



**COMSOL
CONFERENCE**
2018 LAUSANNE



FINITE ELEMENT SIMULATION OF IMPULSE ARC DISCHARGE

Alexander Chusov

OUTLINE:

- **Problem statement**
- **Description of the physical model**
- **Numerical implementation**
- **Validation**
- **Preliminary results**
- **Conclusions**

Lightning protection of overhead lines



Lightning protection of overhead lines



Lightning protection of overhead lines

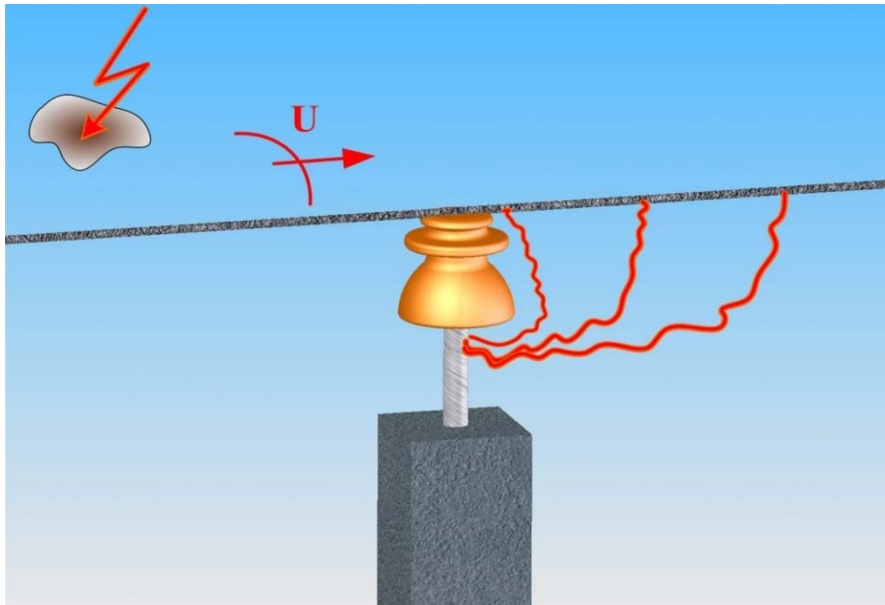

A line with bare conductor

Arc is moving

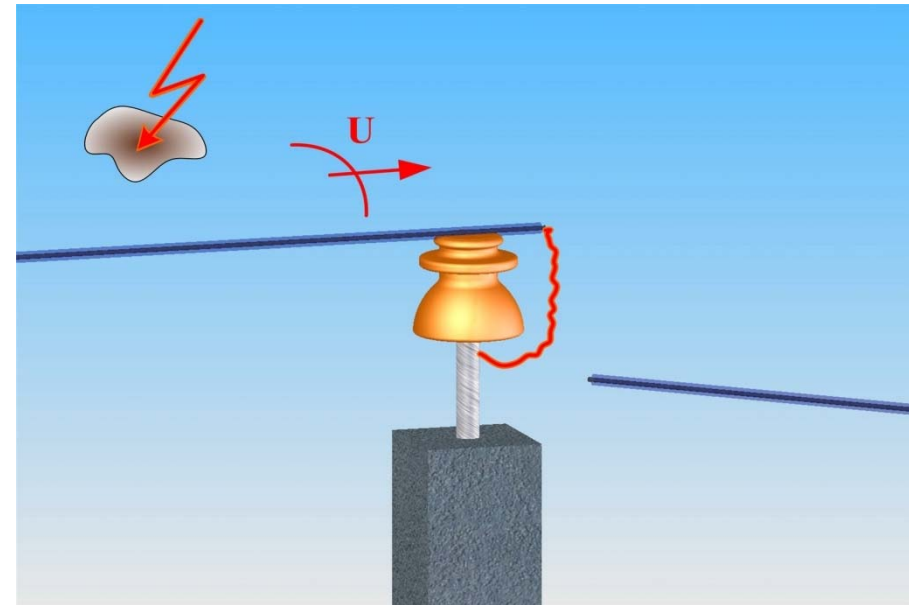

A line with covered conductor

Conductor burn down

Insulator flashover



Lightning protection of overhead lines

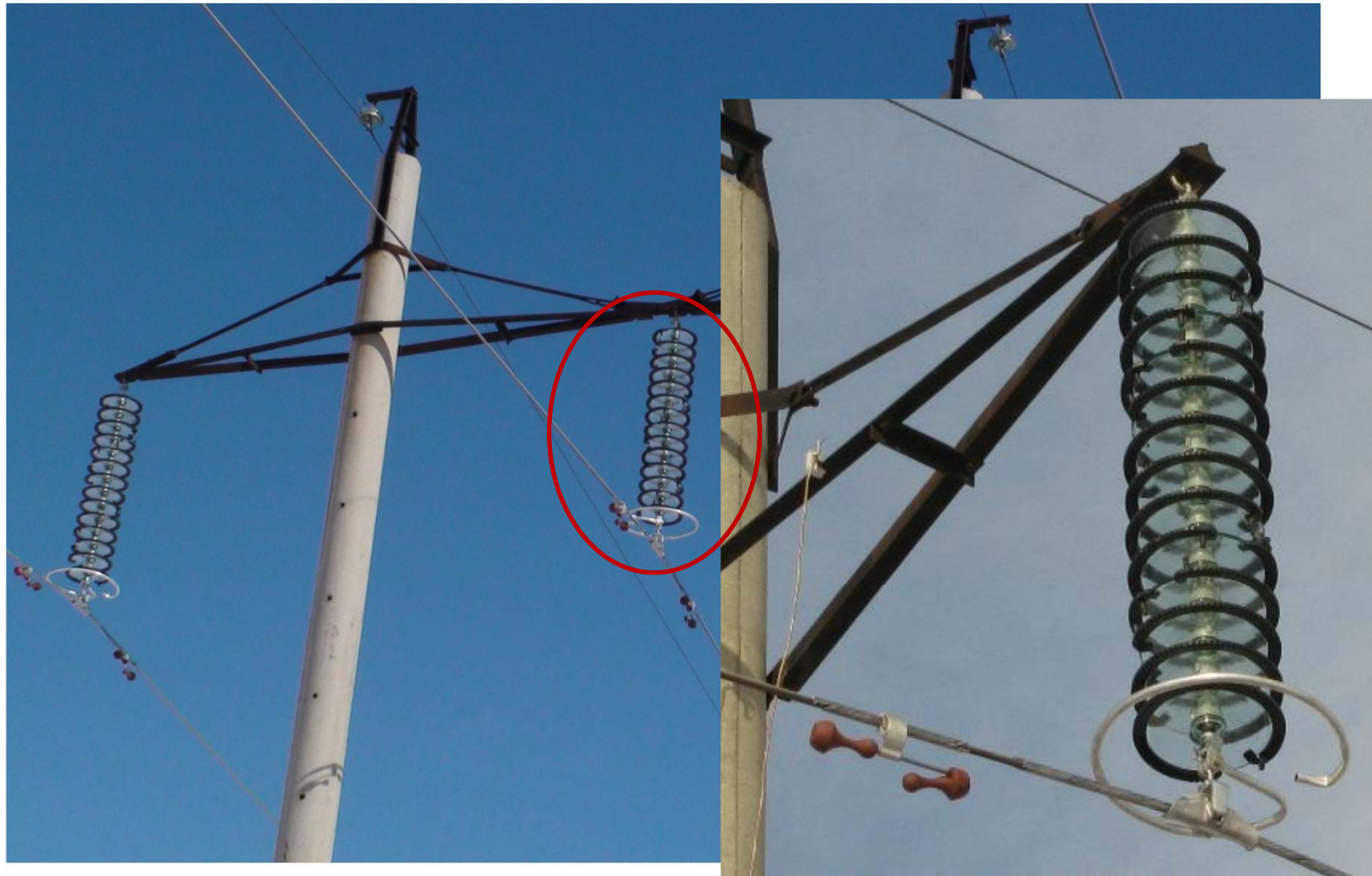

MULTI-CHAMBER ARRESTERS

Lightning protection of overhead power lines up to 35 kV

20 kV

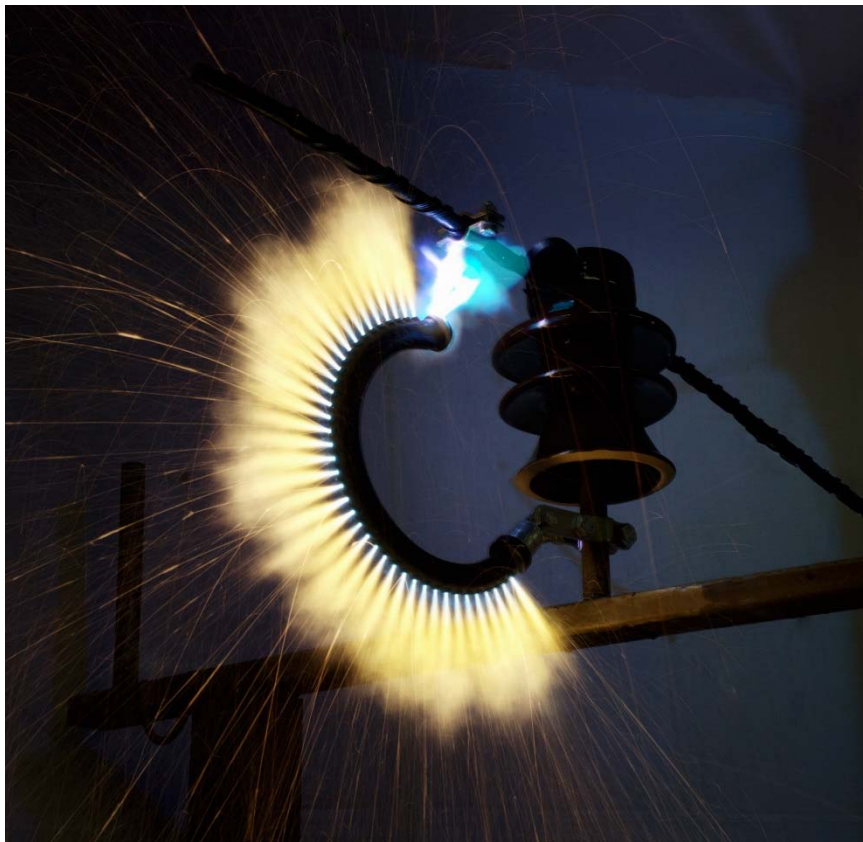

35 kV



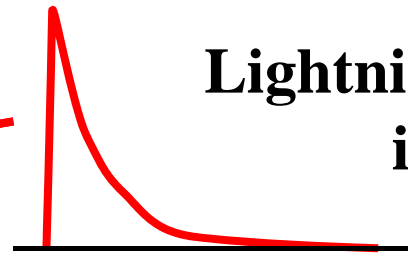
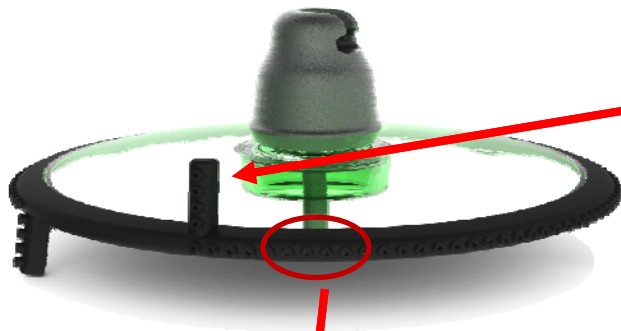

Lightning overvoltage imposed

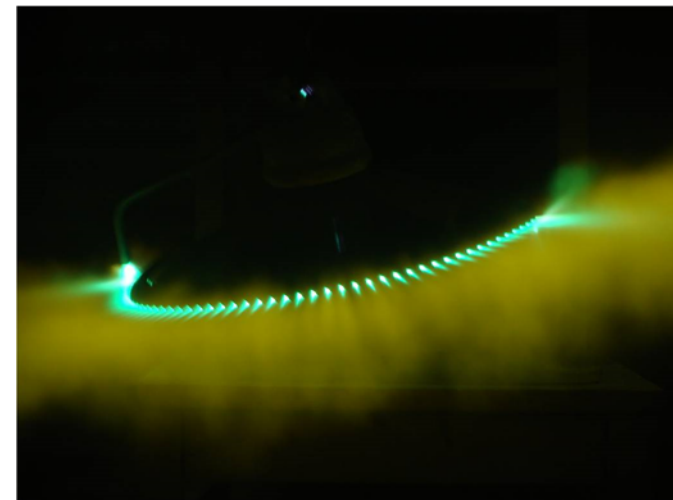
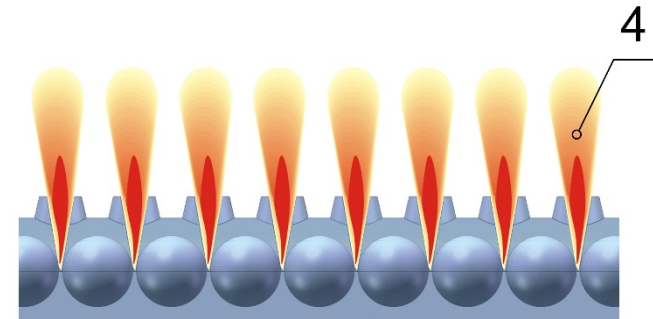
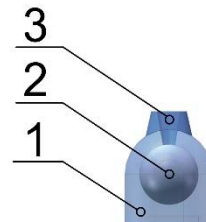
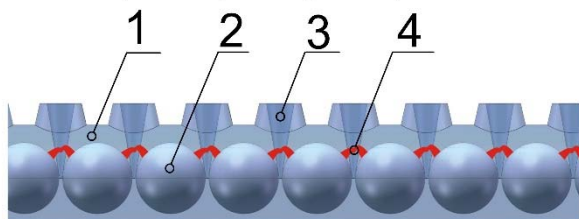
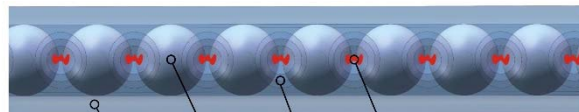

- 1 – silicone rubber length;**
- 2 – intermediate electrodes;**
- 3 – arc quenching chamber;**
- 4 – discharge channel.**

QUENCHING TEST SCHEME

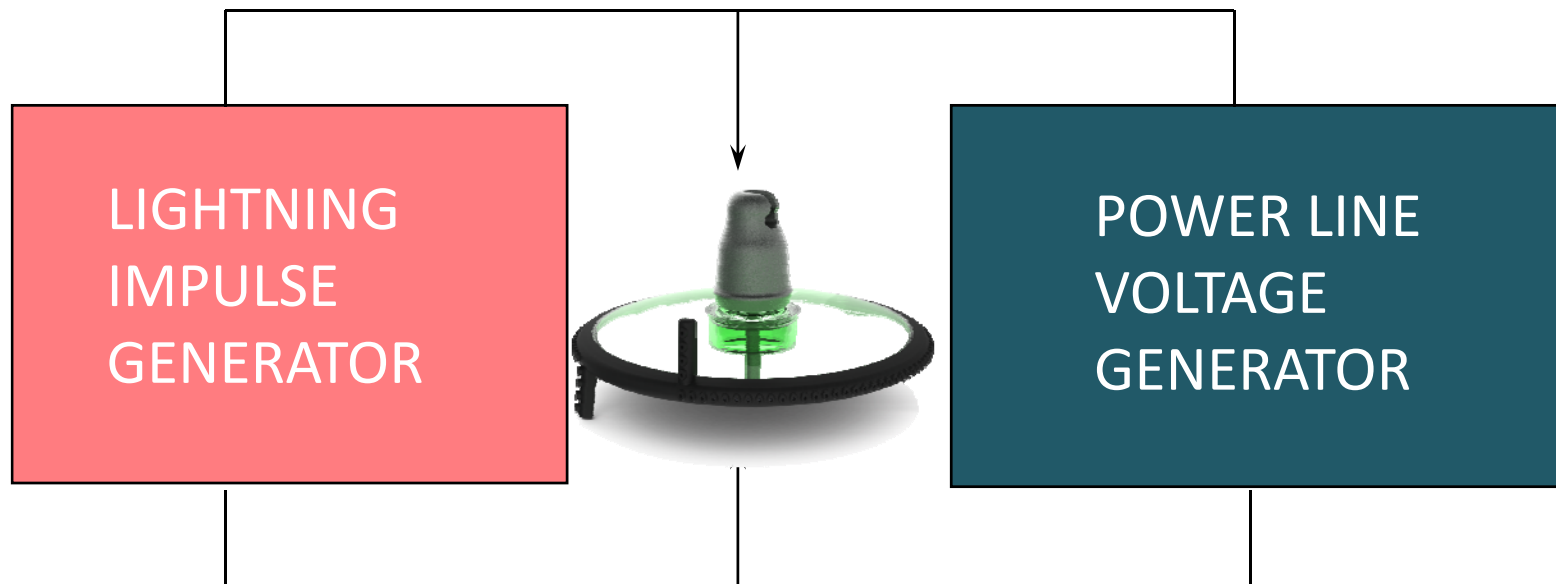
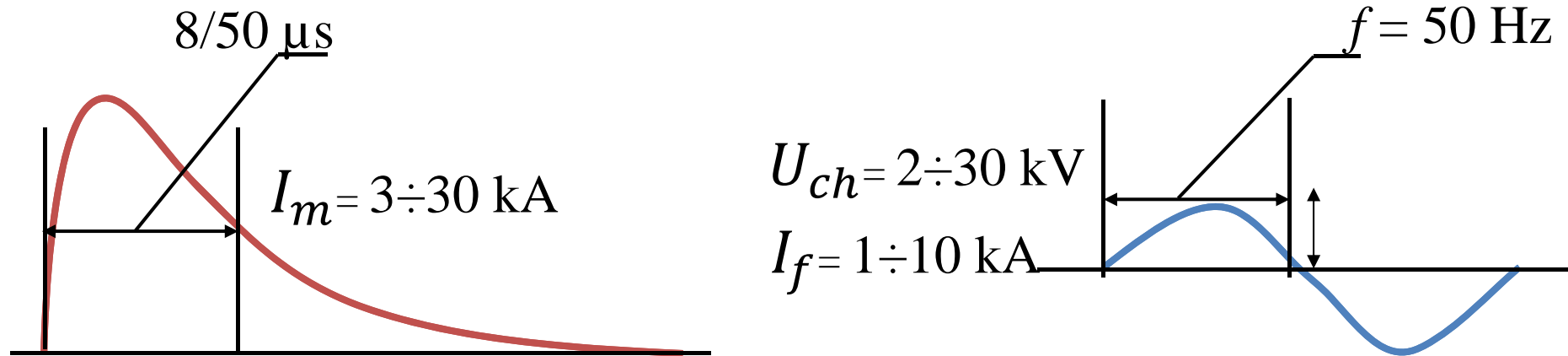

MULTI-CHAMBER ARRESTERS

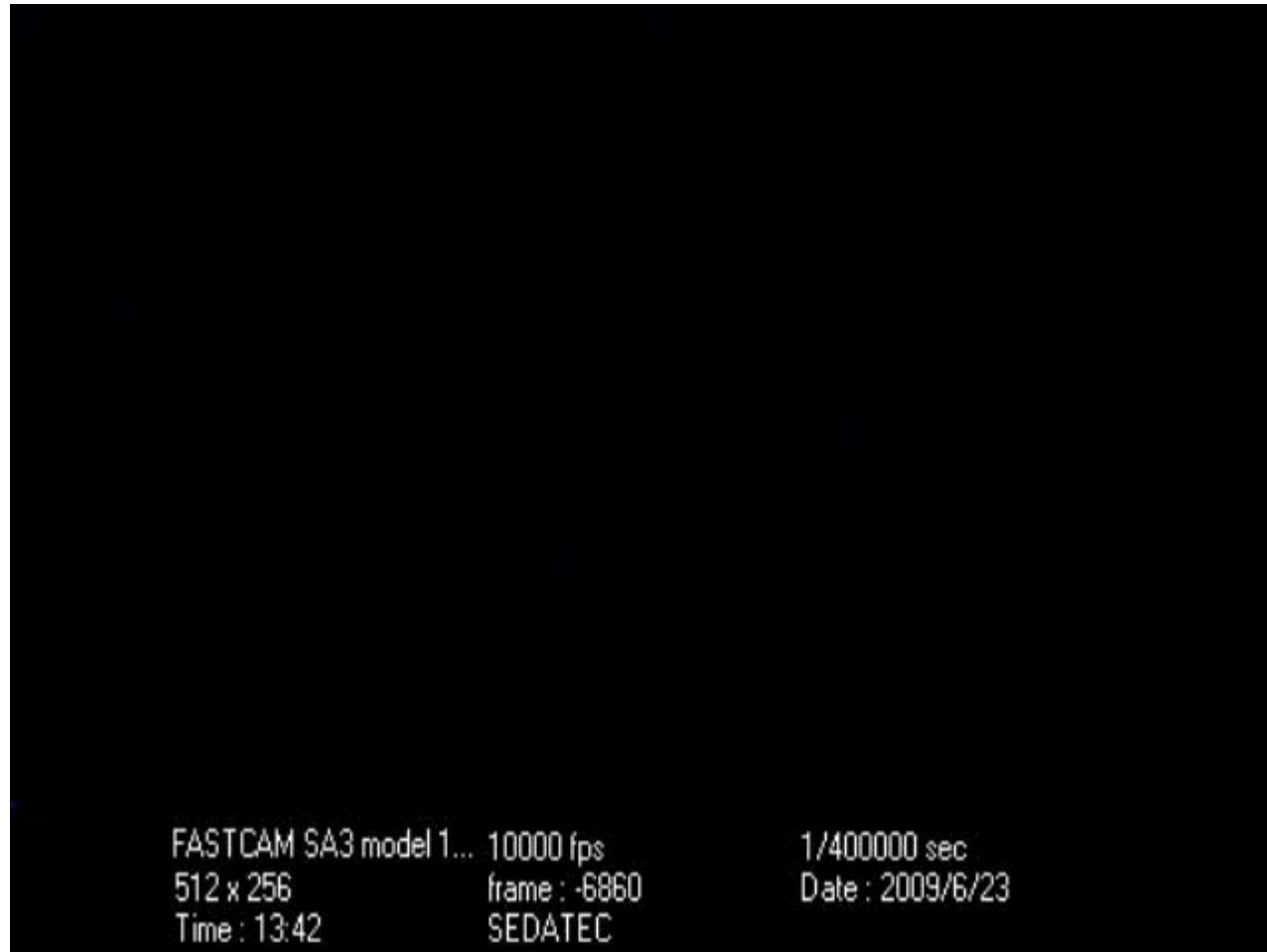

MULTI-CHAMBER ARRESTERS

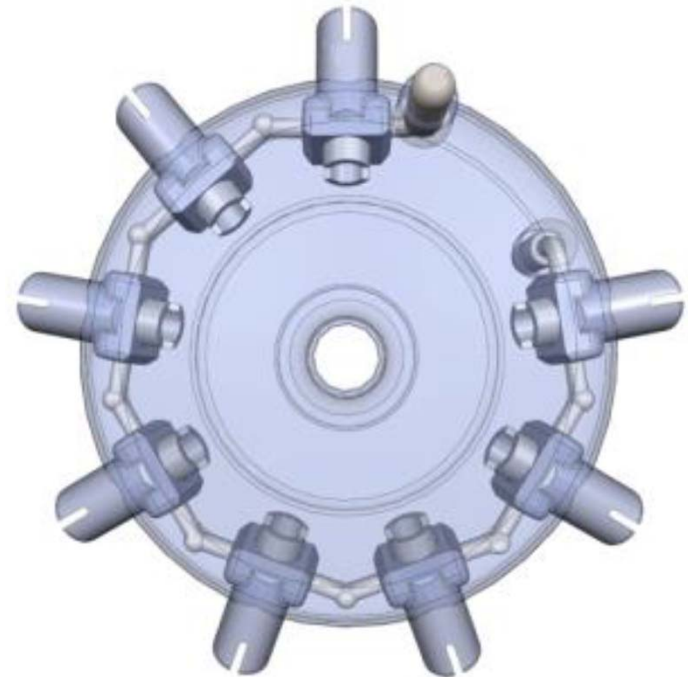

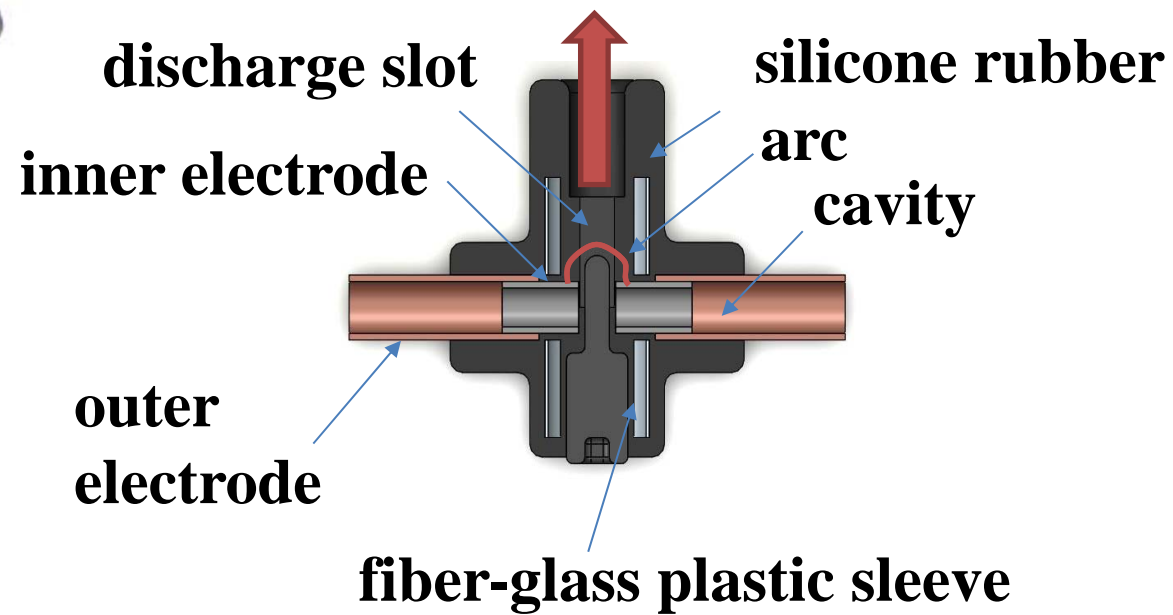
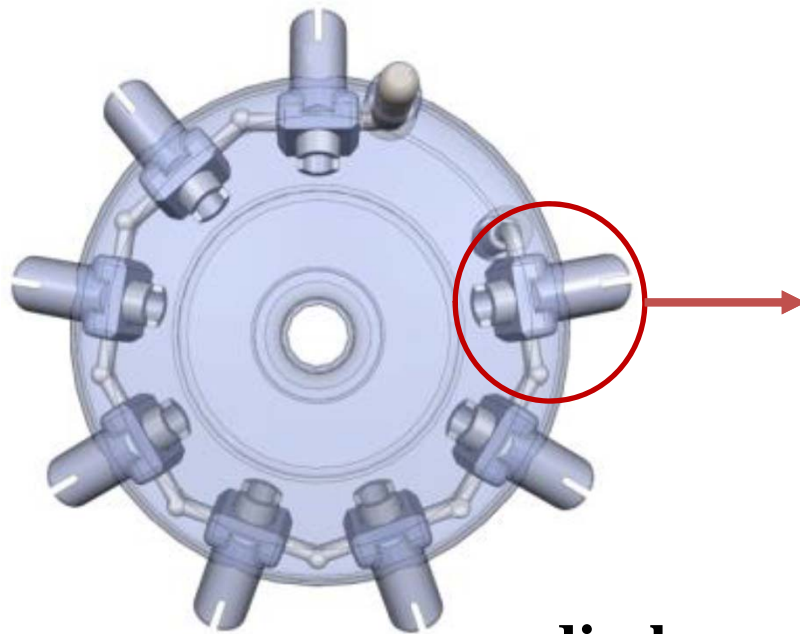

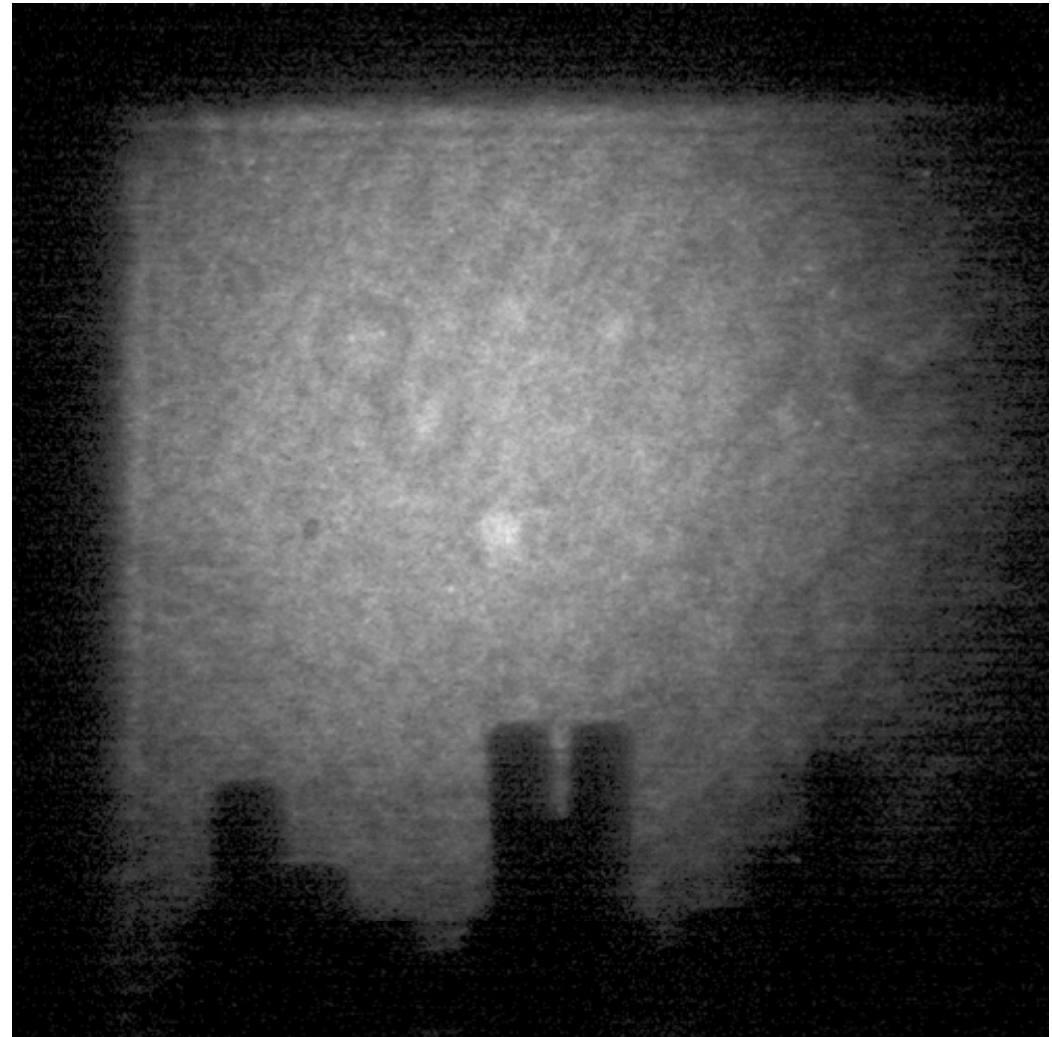
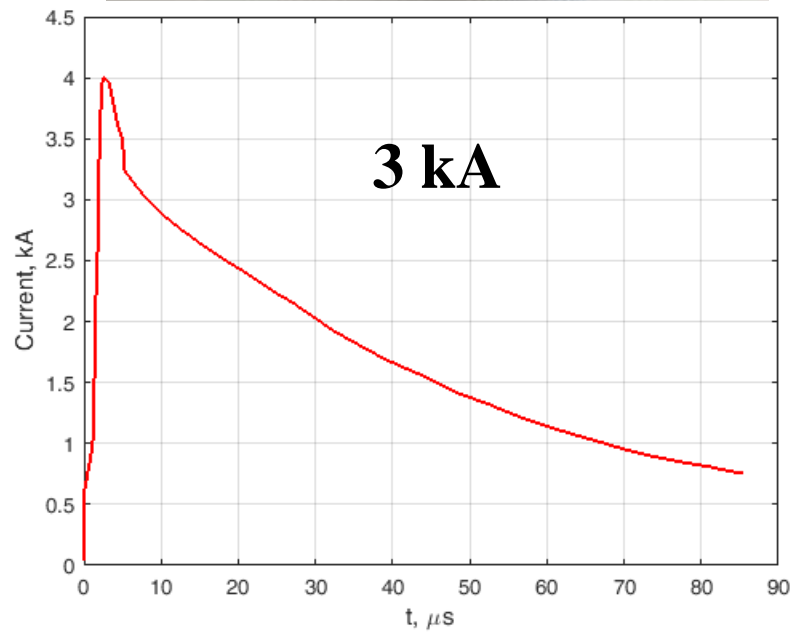

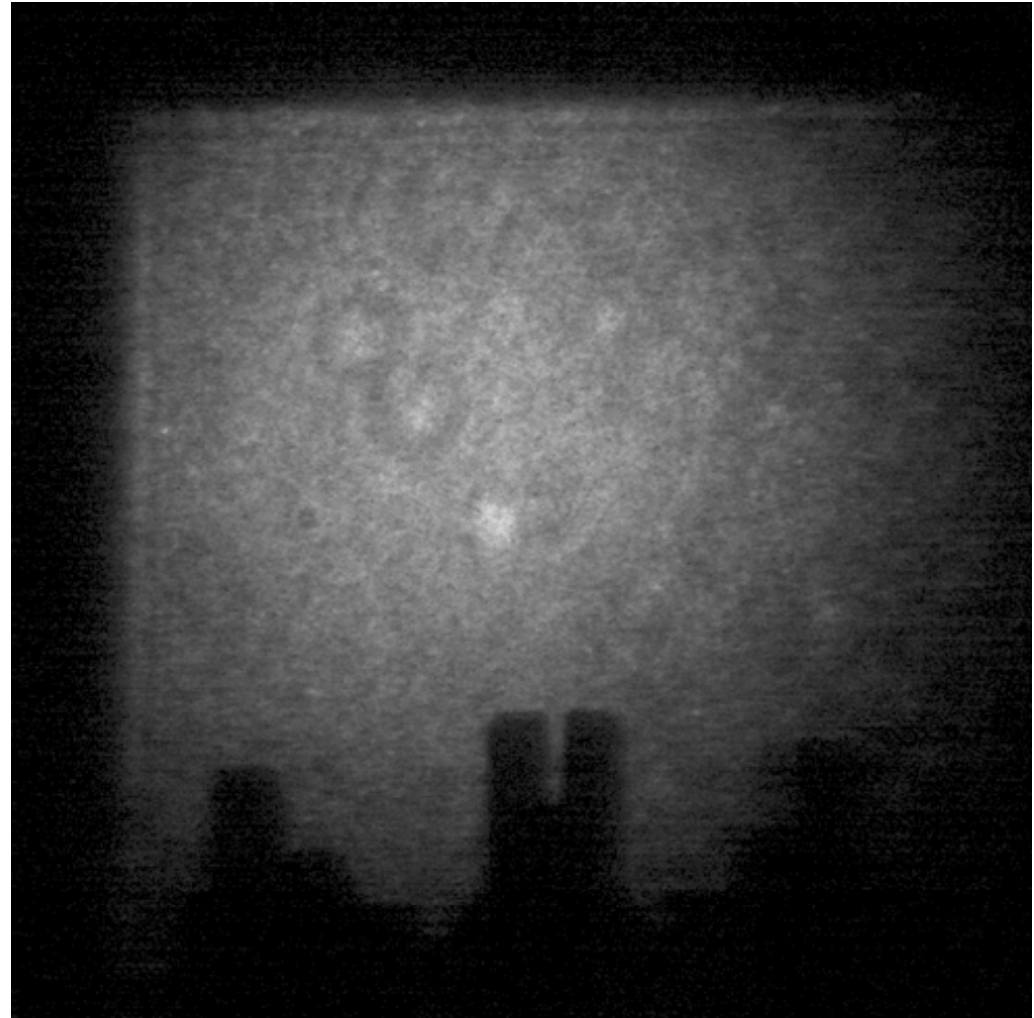
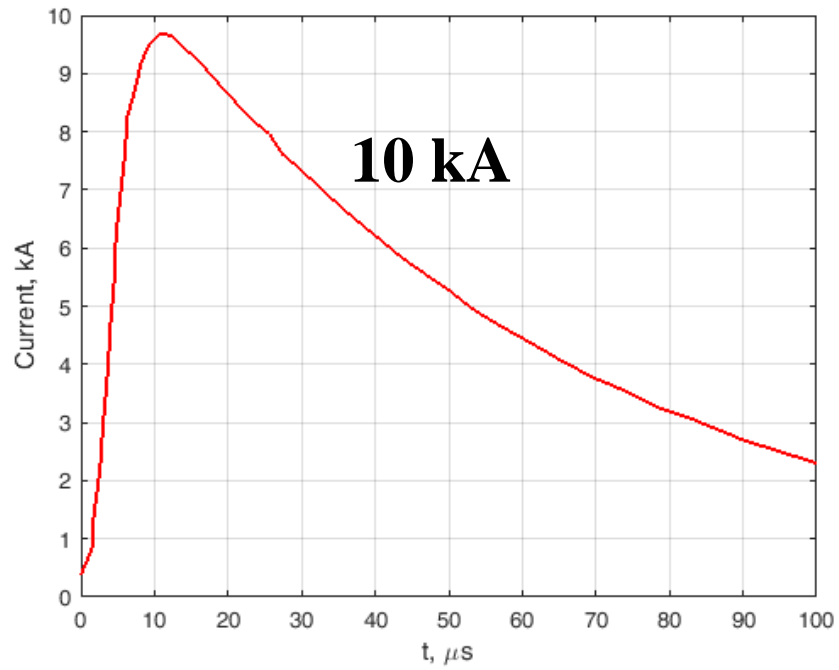

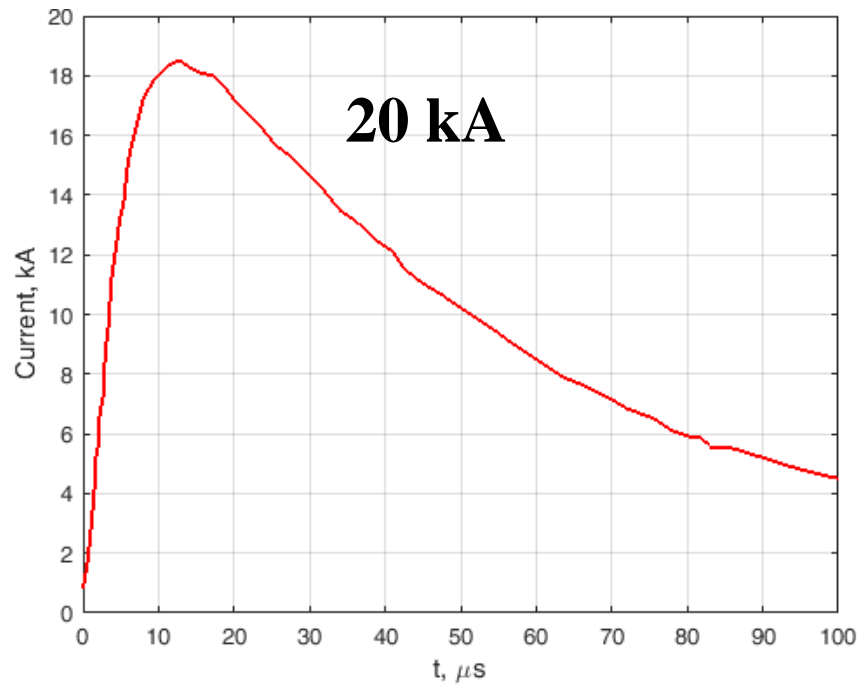
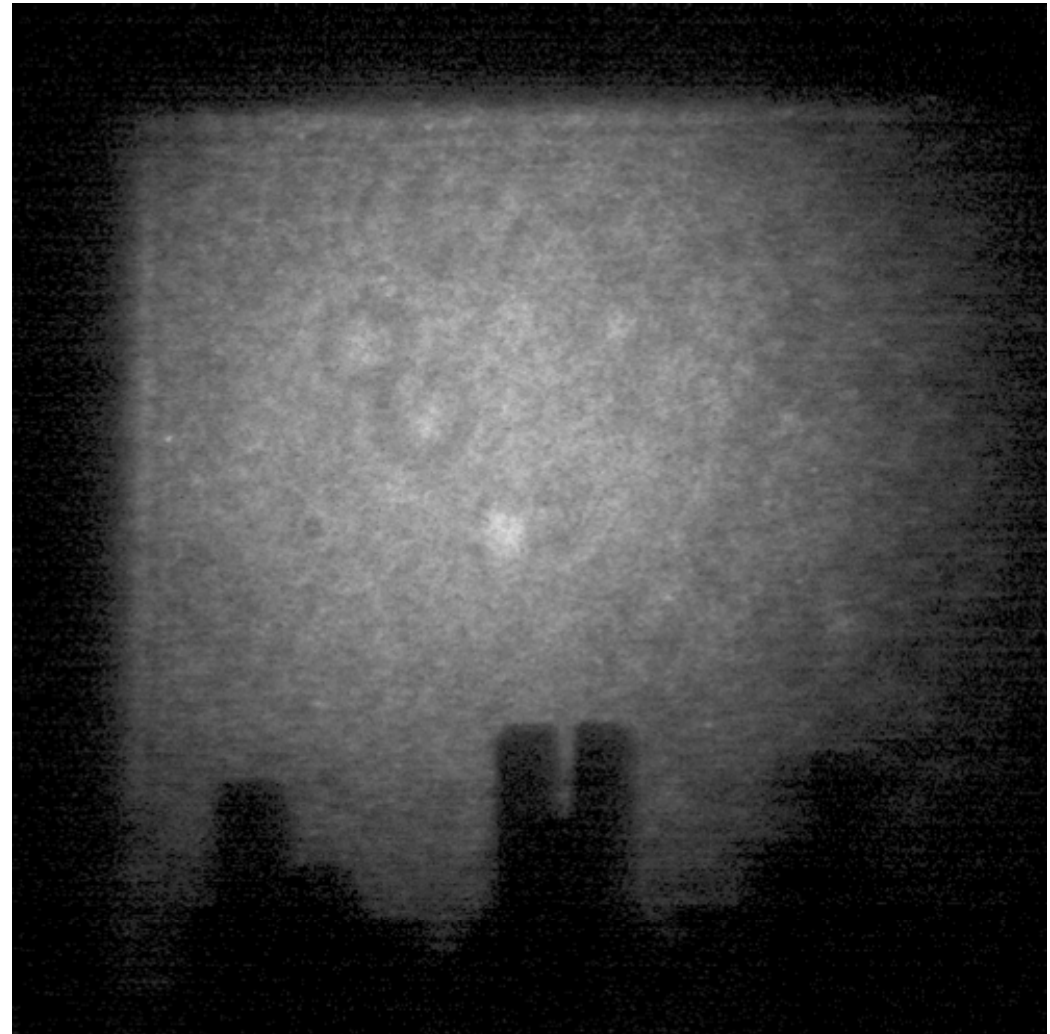

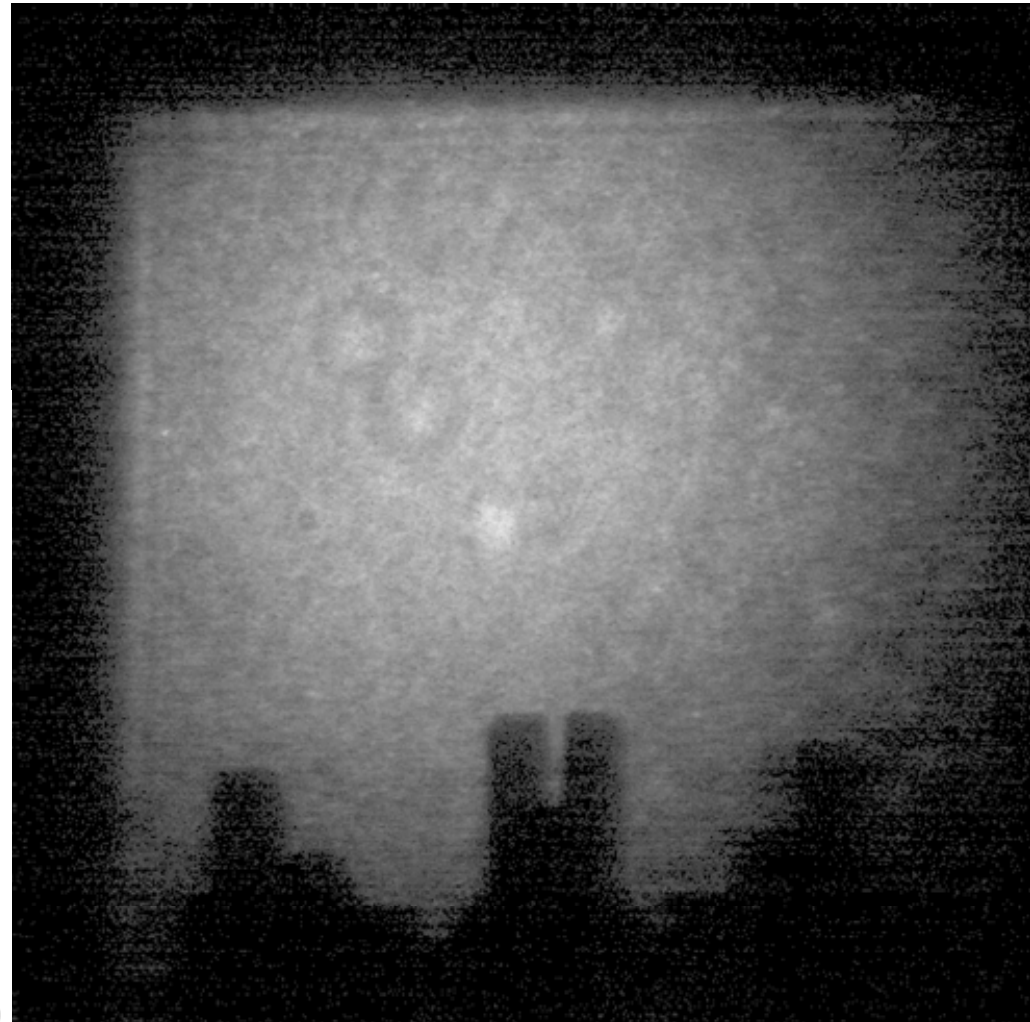
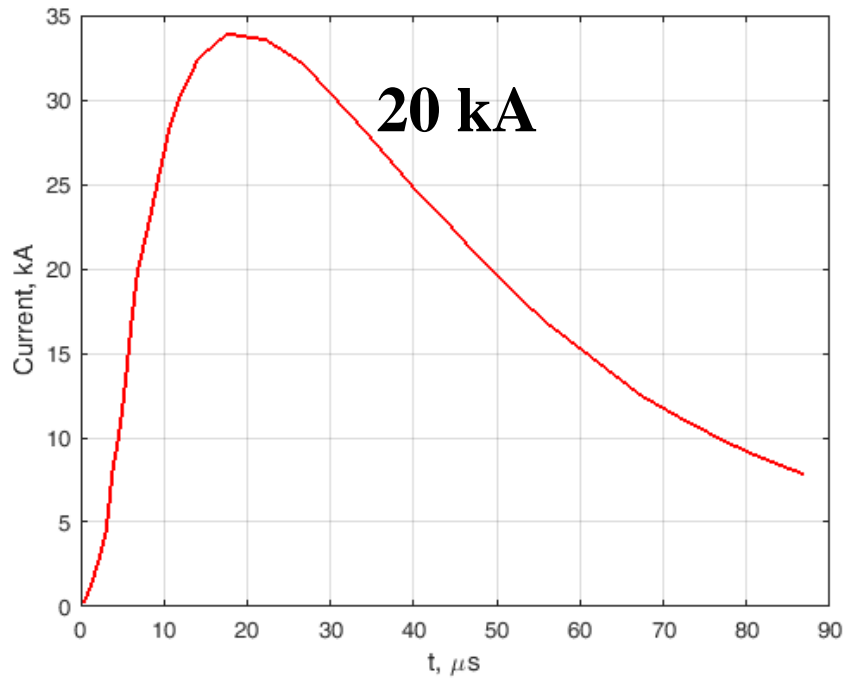

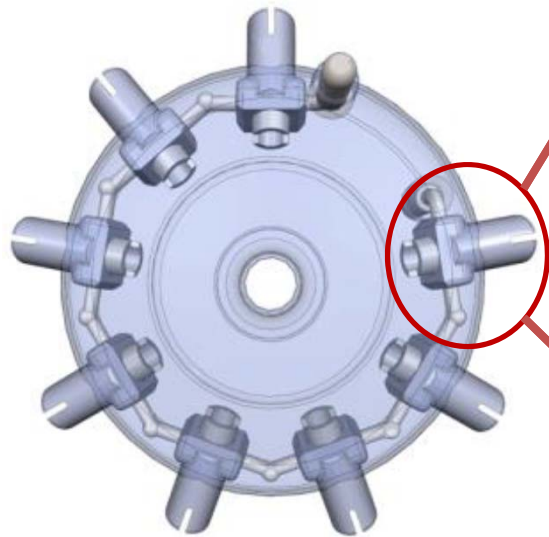

Type #1

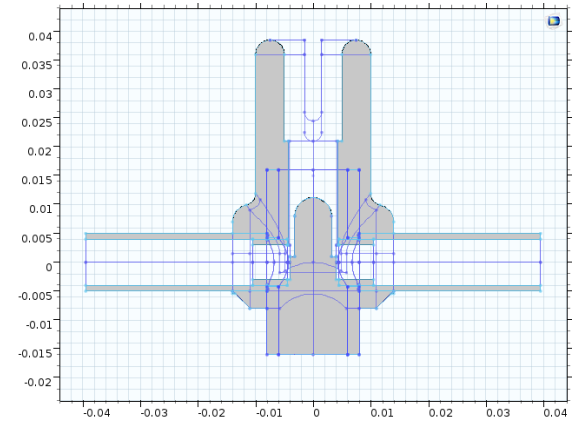

Optimal geometry?



Type #2

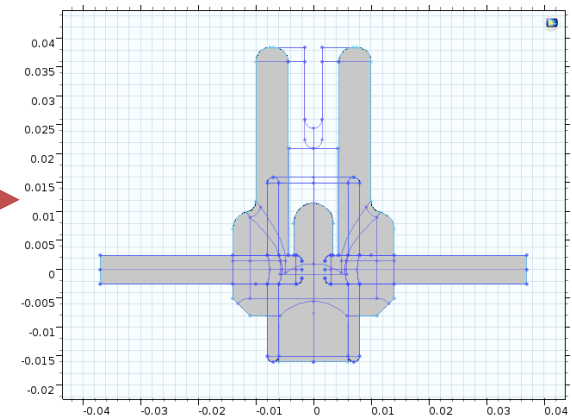

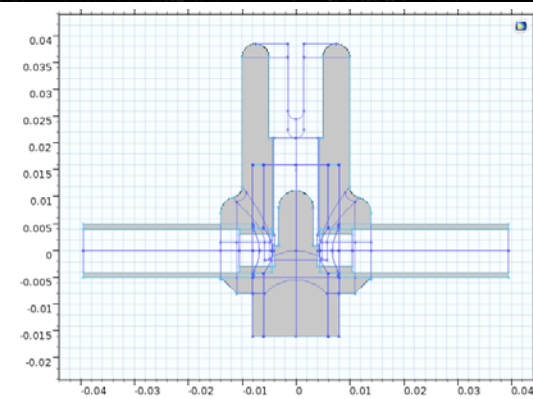
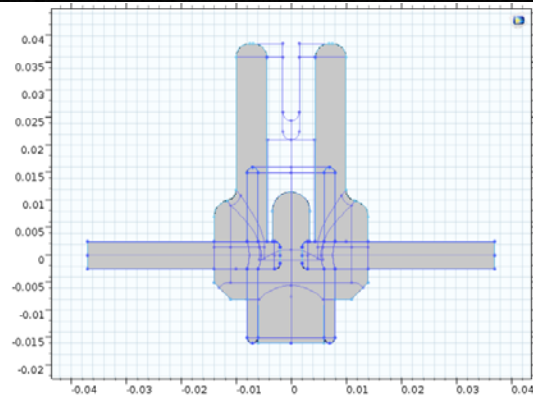
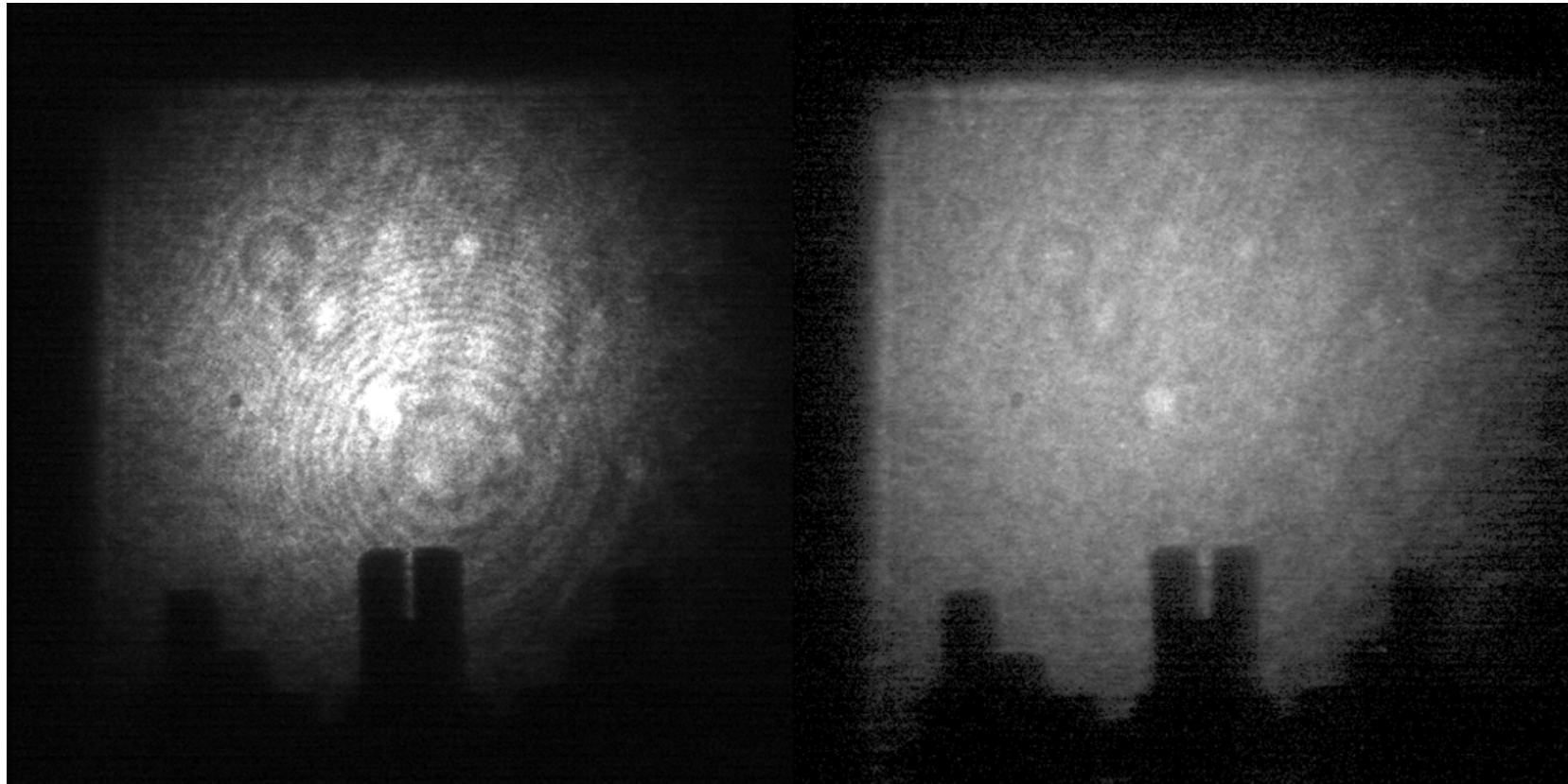

ARC DISCHARGE MODEL

Magnetohydrodynamics equations (MHD)

$$\frac{\partial \rho}{\partial t} + \nabla \cdot \{\rho \mathbf{v}\} = 0$$

$$\frac{\partial (\rho \mathbf{v})}{\partial t} + \nabla \cdot \{\rho \mathbf{v} \otimes \mathbf{v}\} = -\nabla p + \nabla \cdot \mathbf{T} + \mathbf{j} \times \mathbf{B}$$

$$\frac{\partial (\rho H)}{\partial t} + \nabla \cdot \{\rho H \mathbf{v} - \lambda \nabla T\} = \frac{\partial p}{\partial t} + \nabla \cdot (\mathbf{T} \cdot \mathbf{v}) + \mathbf{j} \cdot \mathbf{E} - \nabla \cdot \mathbf{F}$$

$$\mathbf{j} = \sigma (\mathbf{E} + \mathbf{v} \times \mathbf{B})$$

$$\nabla \times \mathbf{B} = \mu_0 \mathbf{j}$$

$$\partial_t \mathbf{B} + \nabla \times \mathbf{E} = 0$$

ARC DISCHARGE MODEL

- **CFD**

- ▶  High Mach Number Flow, Laminar (*hmnf*)

- **Electrodynamics**

- ▶  Electric Currents (*ec*)

- **Radiation Transport**

- ▶  Radiation in Participating Media (*rpm*)

ARC DISCHARGE MODEL

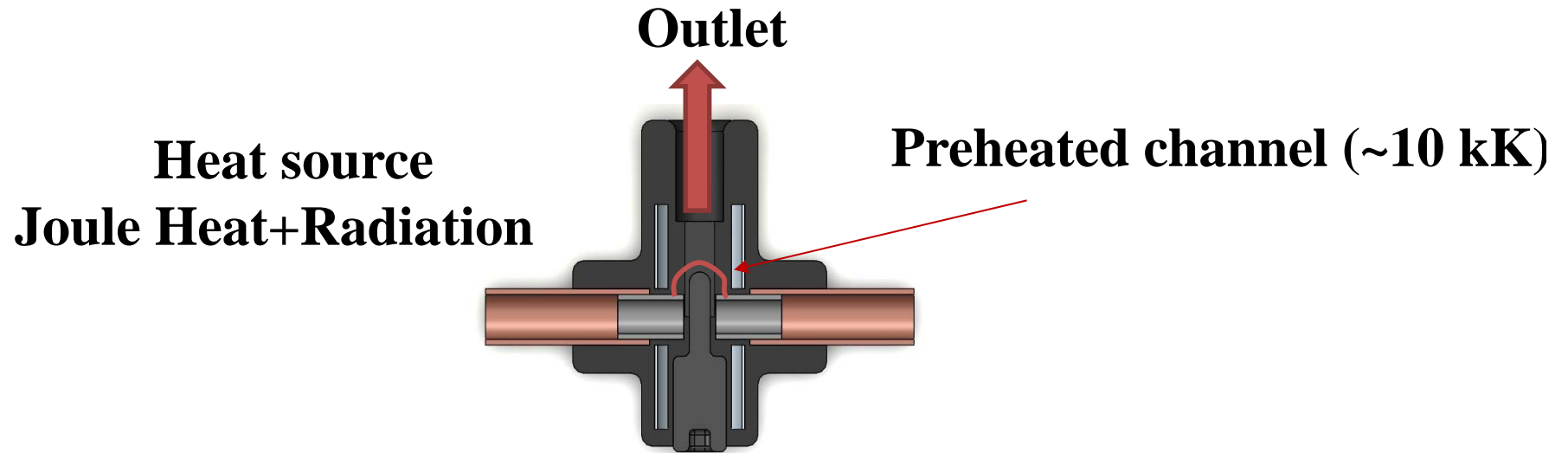

High Mach Number Flow, Laminar (*hmnf*)

- ▶ Fluid 1
- ▶ Initial Values 1
- ▶ Wall 1
- ▶ Thermal Insulation 1
- ▶ Symmetry 1
- ▶ Outlet 1
- ▶ Heat Source 1
- ▶ Initial Values 2

General source

Q_0 User defined

$ec.Q_{rh} + rpm.Q_r + rpm2.Q_r$ W/m^3

Joule Heat Radiation

ARC DISCHARGE MODEL

- **CFD**

- ▶  High Mach Number Flow, Laminar (*hmnf*)

- **Electrodynamics**





- ▶  Electric Currents (*ec*)

- **Radiation Transport**

- ▶  Radiation in Participating Media (*rpm*)

ARC DISCHARGE MODEL

Electrodynamics

- ⚡ Electric Currents (ec)
 - ▶  Current Conservation 1
 - ▶  Electric Insulation 1
 - ▶  Initial Values 1
 - ▶  Terminal 1
 - ▶  Ground 1

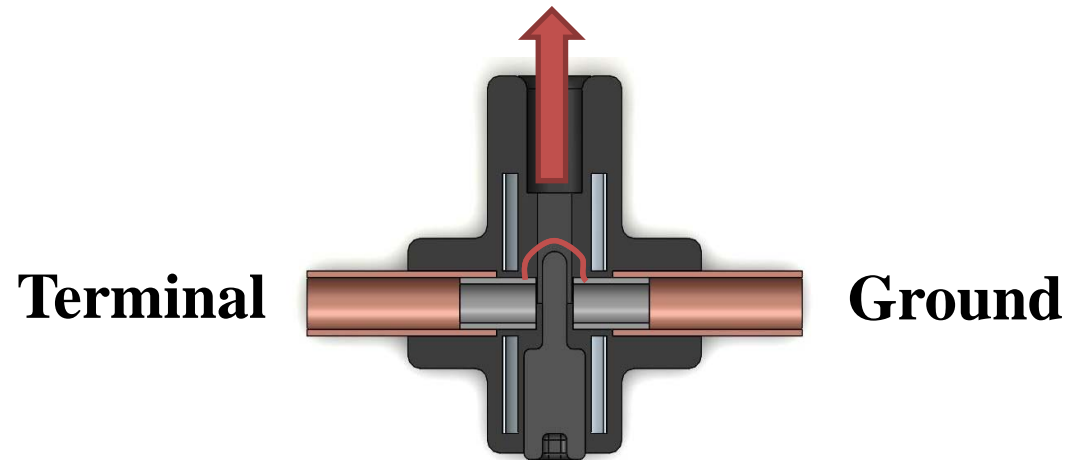

Terminal type:

Current

Current:

I_0 CurrentPulse(t) A

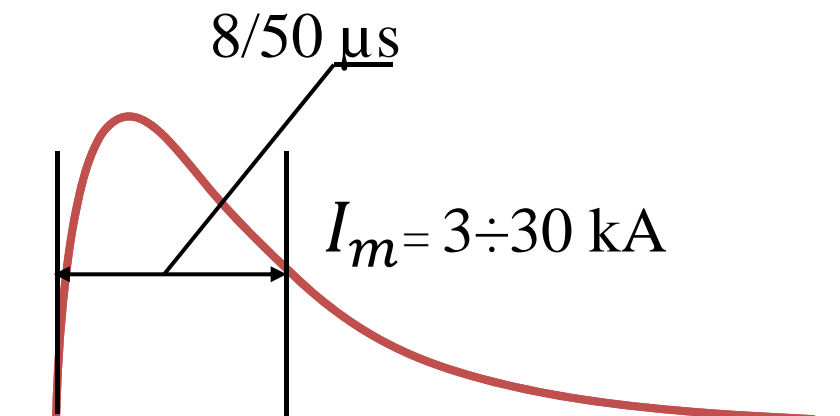

ARC DISCHARGE MODEL

- **CFD**

- ▶  High Mach Number Flow, Laminar (*hmnf*)

- **Electrodynamics**

- ▶  Electric Currents (*ec*)

- **Radiation Transport**





- ▶  Radiation in Participating Media (*rpm*)

Radiation transport

$$\mathbf{s} \cdot \nabla I_\nu(\mathbf{r}, \mathbf{s}) = \kappa_\nu [I_\nu^b(T) - I_\nu(\mathbf{r}, \mathbf{s})]$$

$$I_\nu^b(T) = \frac{2h}{c^2} \frac{\nu^3}{e^{h\nu/k_B T} - 1} \quad G_\nu(r, s) = \int_{4\pi} I_\nu(r, s) d\Omega$$

$$\nabla \cdot \left(\frac{1}{\kappa_\nu} \nabla G_\nu \right) = 3\kappa_\nu (G_\nu - 4\pi I_{b\nu})$$

- ▶  Radiation in Participating Media (*rpm*)
 - ▶  Radiation in Participating Media 1
 - ▶  Opaque Surface 1
 - ▶  Incident Intensity 1

▼ Equation

Equation form:

Study controlled ▼

Show equation assuming:

Study 1, Time Dependent ▼

$Q_r = \kappa(G - 4\pi I_b)$

$\nabla \cdot (D_{P1} \nabla G) + \kappa(G - 4\pi I_b) = 0$

▼ Participating Media Settings

Radiation discretization method:

P1 approximation ▼

Radiation transport

Two-band model

from zero up to $\lambda = 120 \text{ nm}$

$$\alpha = 2000 \text{ m}^{-1}$$

from $\lambda = 120 \text{ nm}$ up to $\lambda = 1 \text{ mm}$

$$\alpha = 50 \text{ m}^{-1}$$

- ▶  Radiation in Participating Media (*rpm*)
- ▶  Radiation in Participating Media 2 (*rpm2*)

▼ Absorption

Absorption coefficient:

κ

1/m

▼ Absorption





Absorption coefficient:











κ

1/m

ARC DISCHARGE MODEL

Material properties

- ▷  High Mach Number Flow, Laminar (*hmnf*)
- ▷  Electric Currents (*ec*)
- ▷  Radiation in Participating Media (*rpm*)
- ▷  Radiation in Participating Media 2 (*rpm2*)

- ▲  Materials
 - ▲  Air (*mat1*)
 - ▲  Basic (*def*)
 -  Interpolation 1 (*rho*)
 -  Interpolation 2 (*cp*)
 -  Interpolation 3 (*mu*)
 -  Interpolation 4 (*k*)
 -  Interpolation 5 (*sigma*)
 - ▲  Radiation heat transfer (*RadiationHeatTransfer*)
 -  Interpolation 1 (*Qrad*)
 -  Ideal gas (*idealGas*)

ARC DISCHARGE MODEL

Material properties

$$\sigma(p, T)$$

$$\rho(p, T)$$

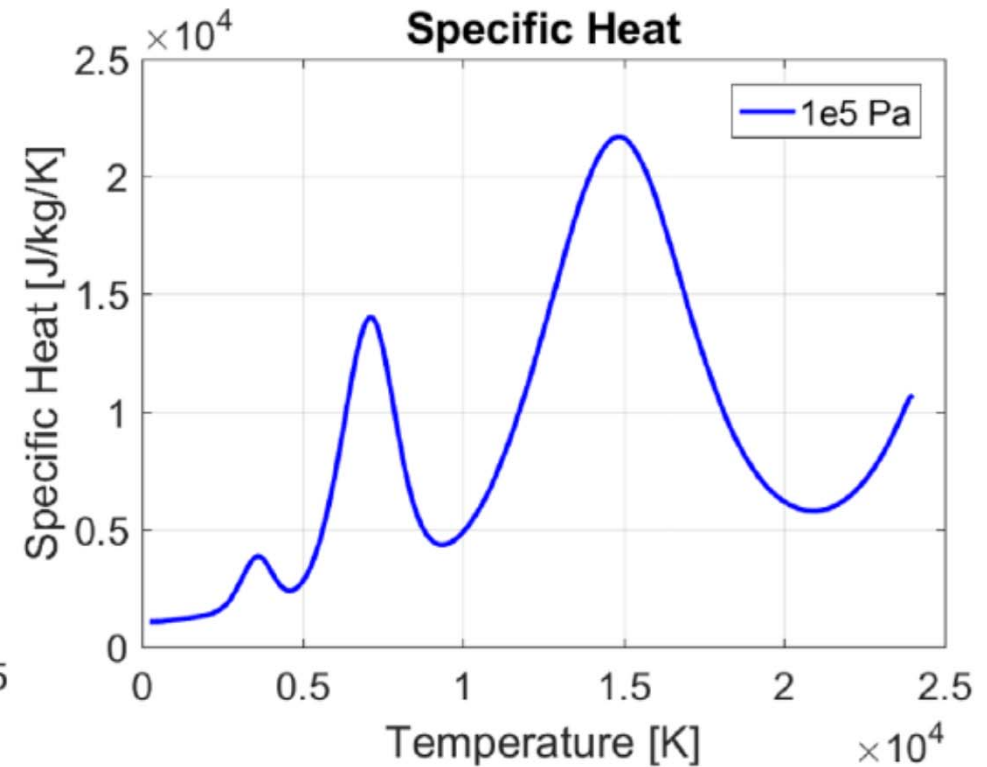
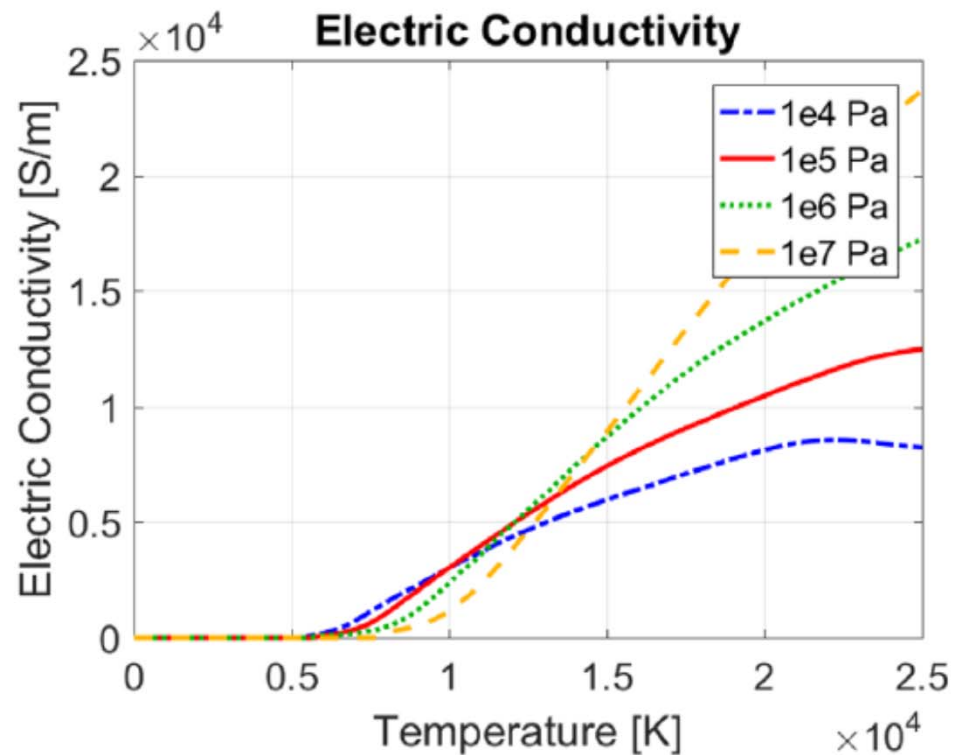

ARC DISCHARGE MODEL

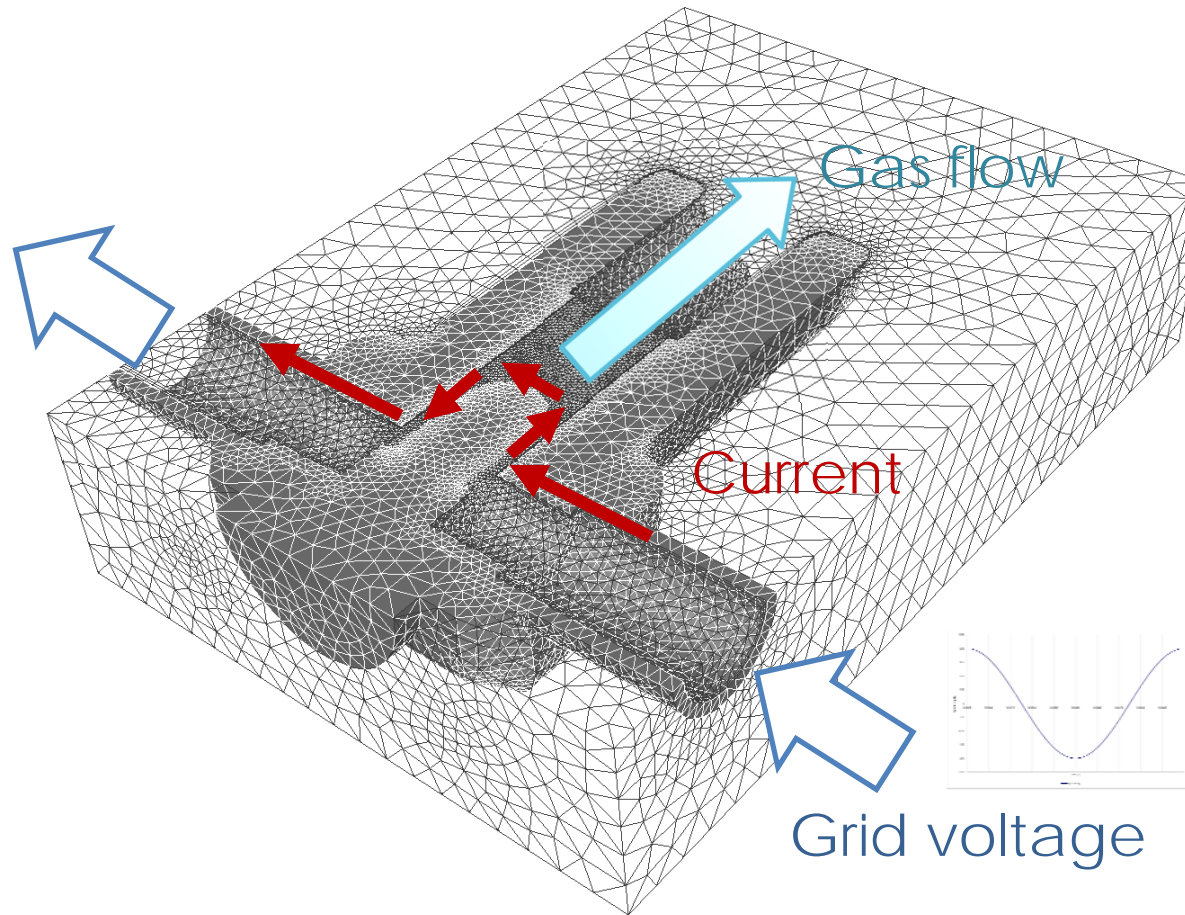

ARC MODEL VALIDATION

Open spark gap



Steel electrodes





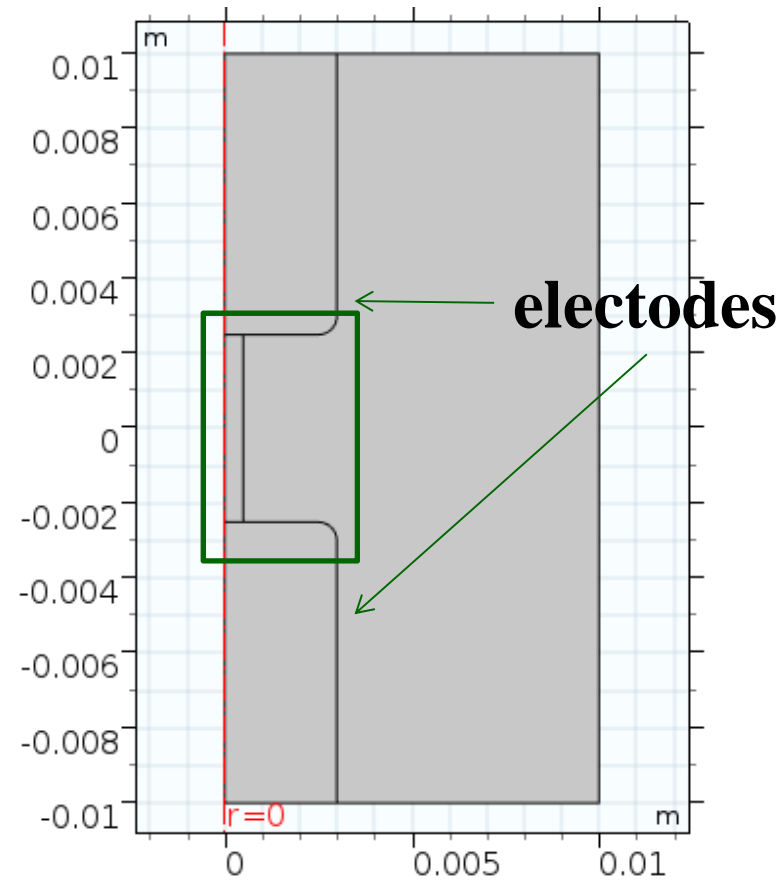
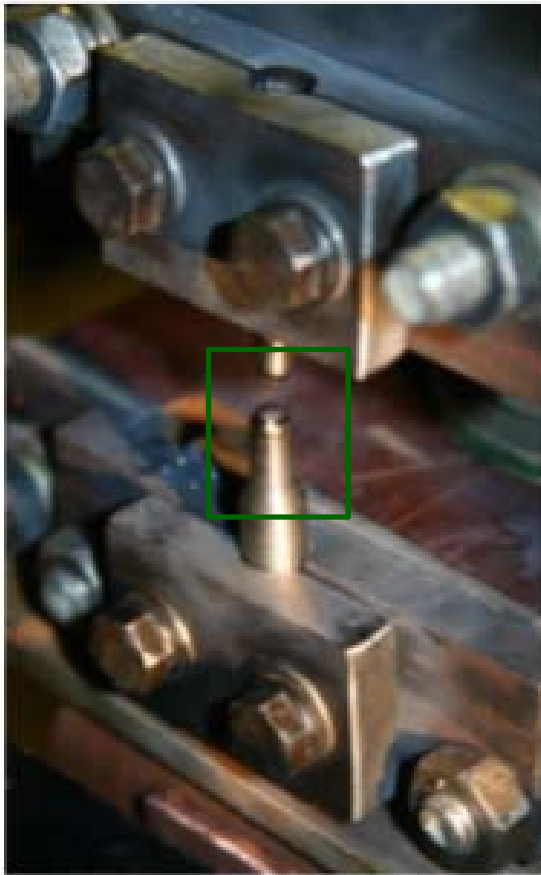

ARC MODEL VALIDATION

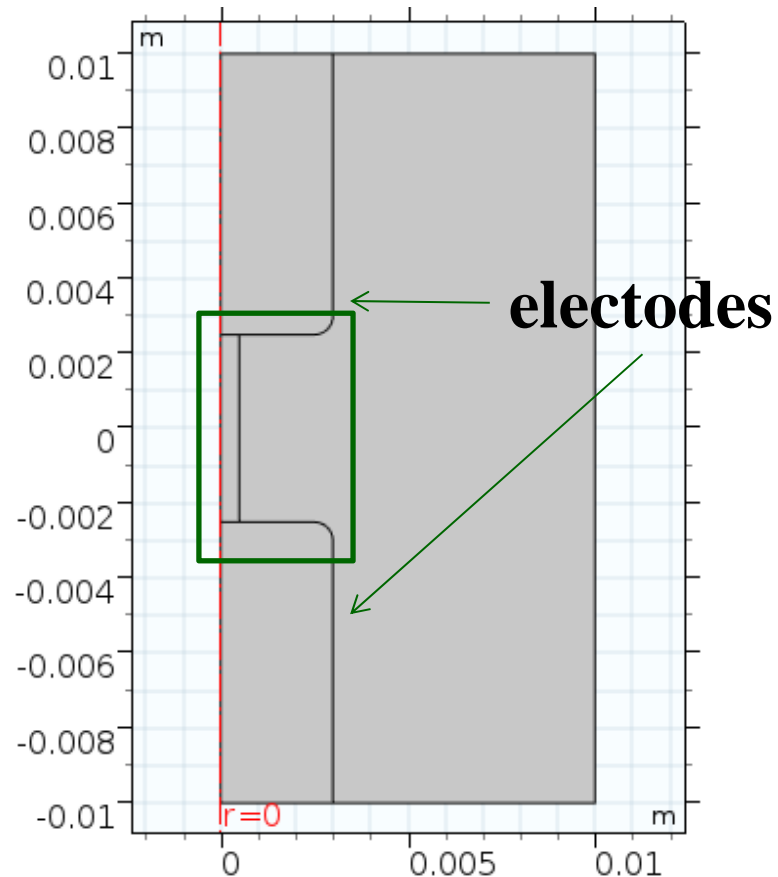

ARC MODEL VALIDATION



- ▶  High Mach Number Flow, Laminar (*hmnf*)
- ▶  Electric Currents (*ec*)
- ▶  Radiation in Participating Media (*rpm*)
- ▶  Radiation in Participating Media 2 (*rpm2*)

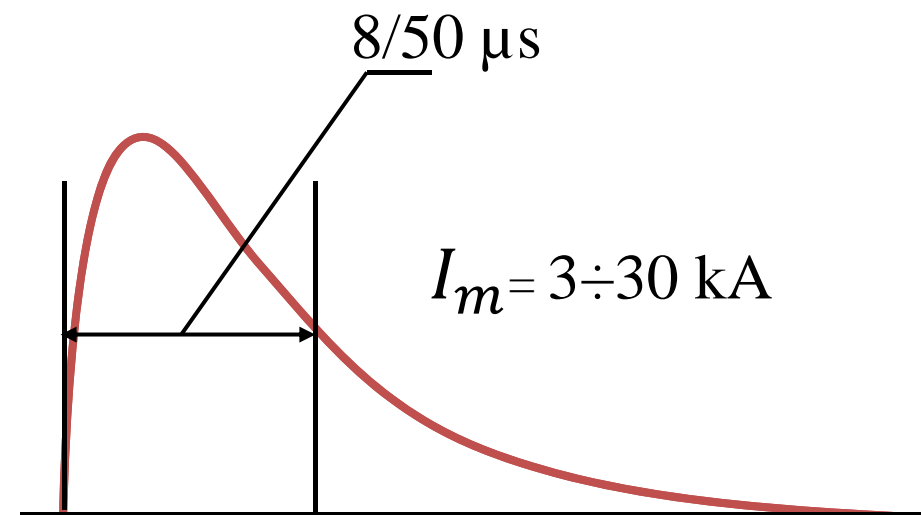

SIMULATION RESULTS

30 kA

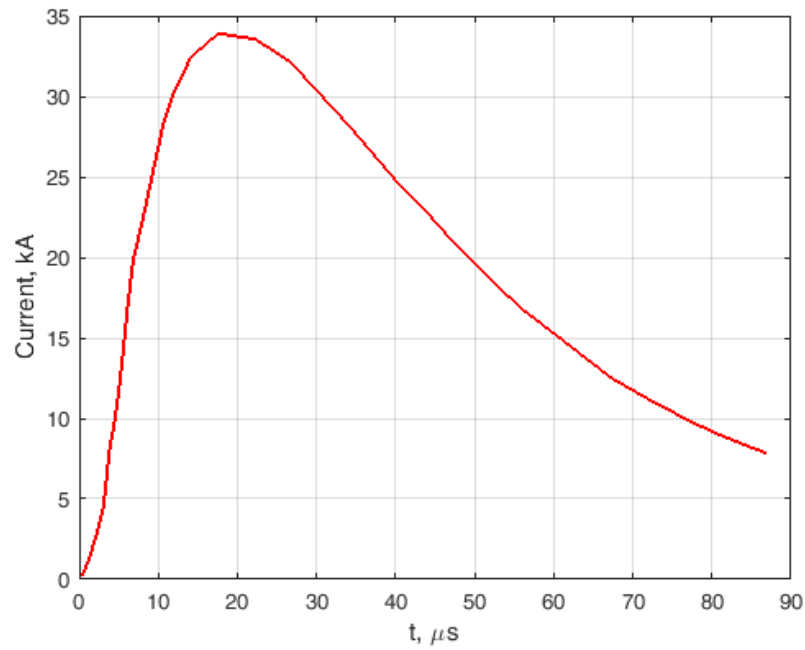

Temperature, K

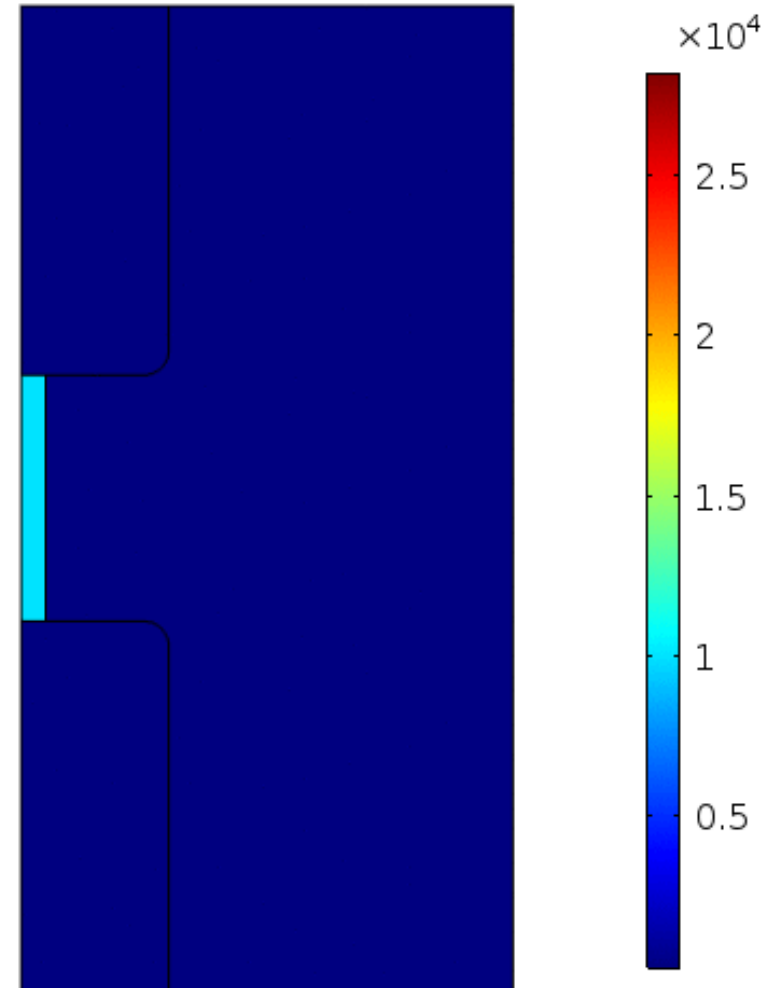

SIMULATION RESULTS

30 kA

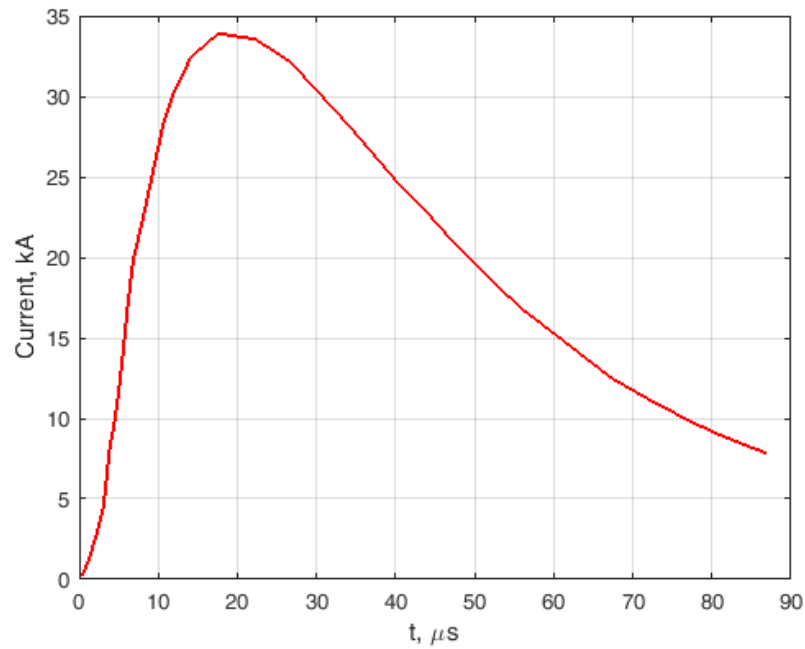

Pressure, Pa

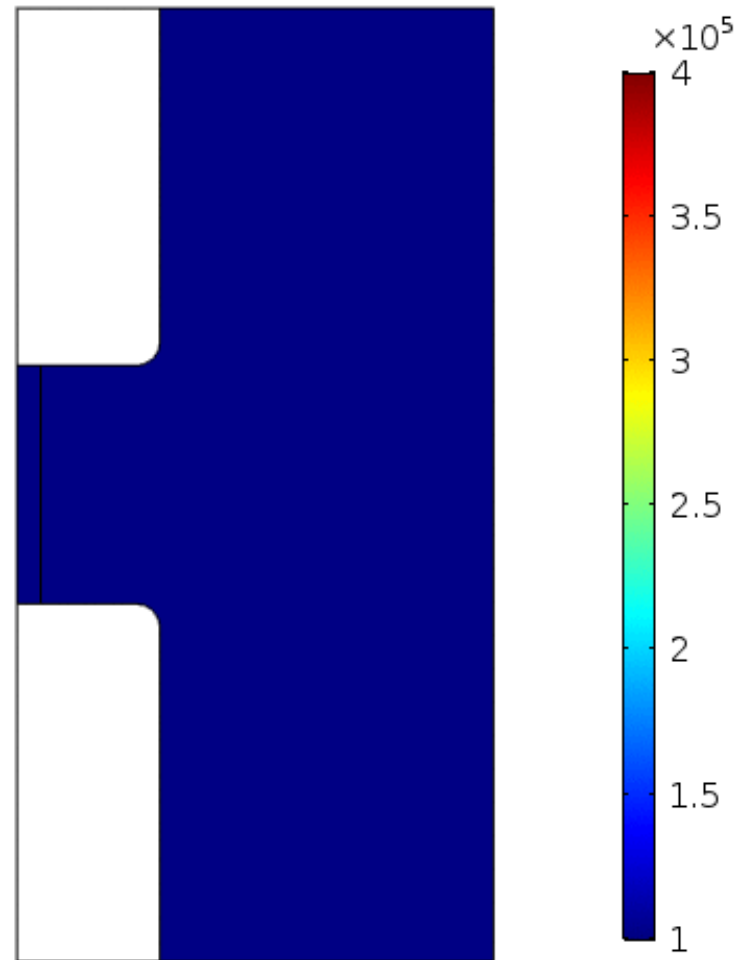

SIMULATION RESULTS

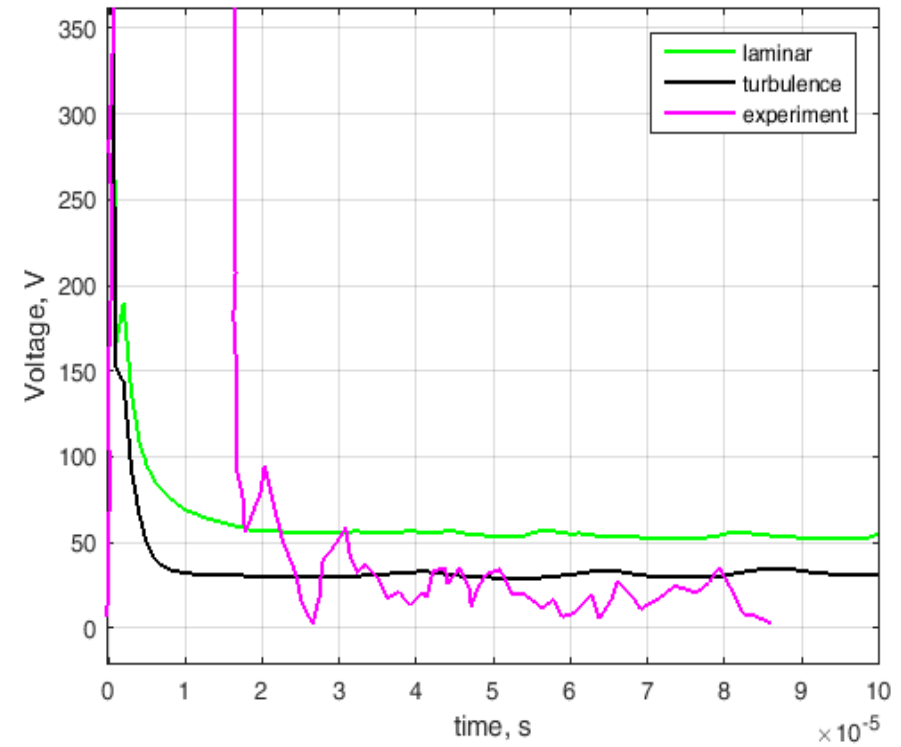
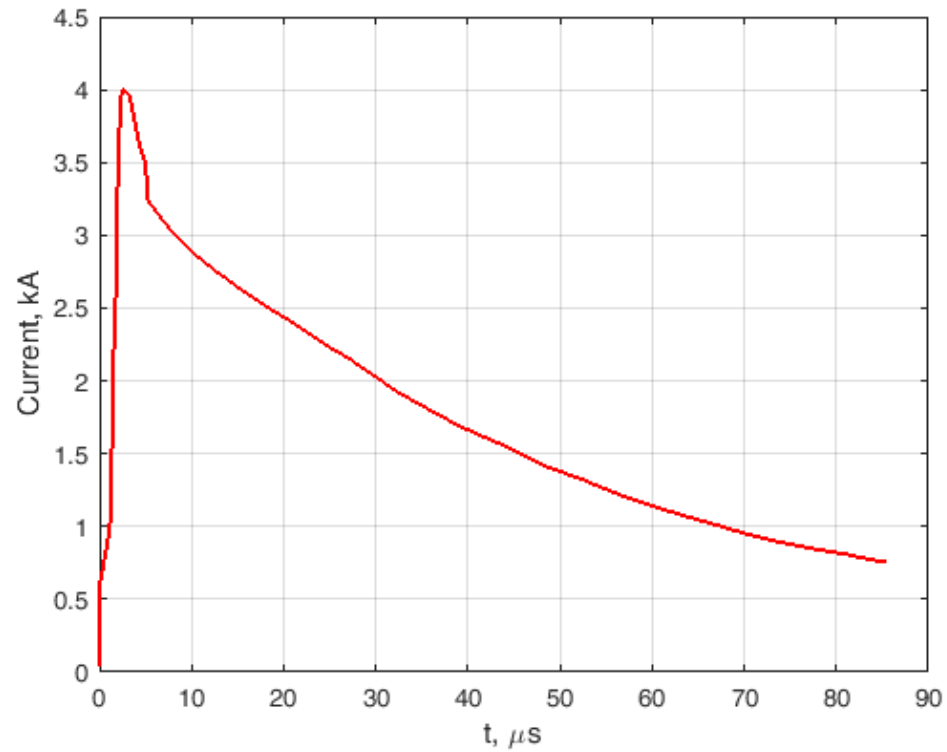

3 kA

SIMULATION RESULTS

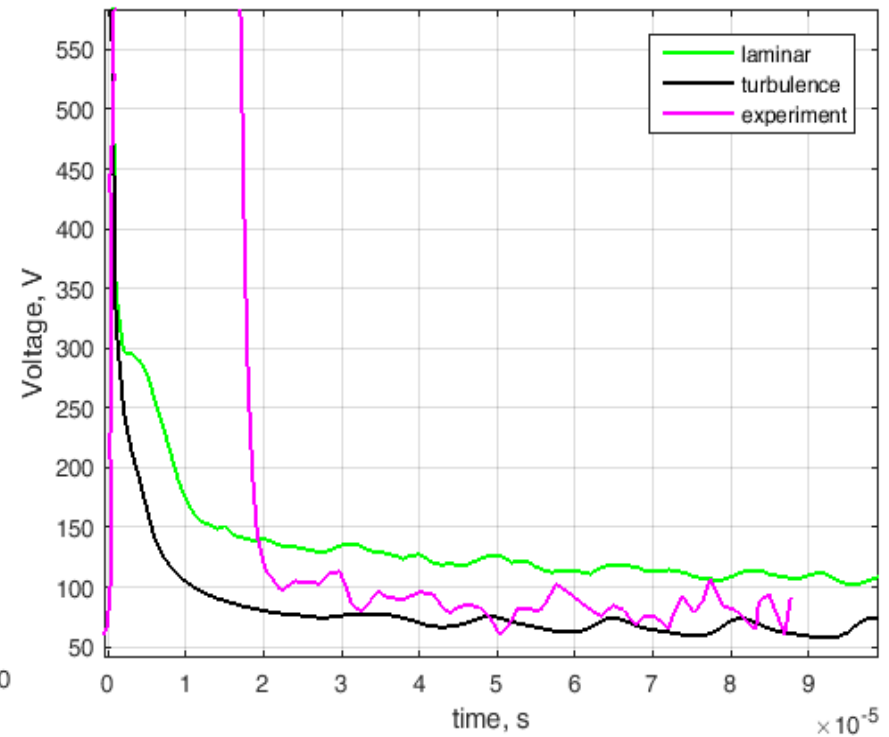
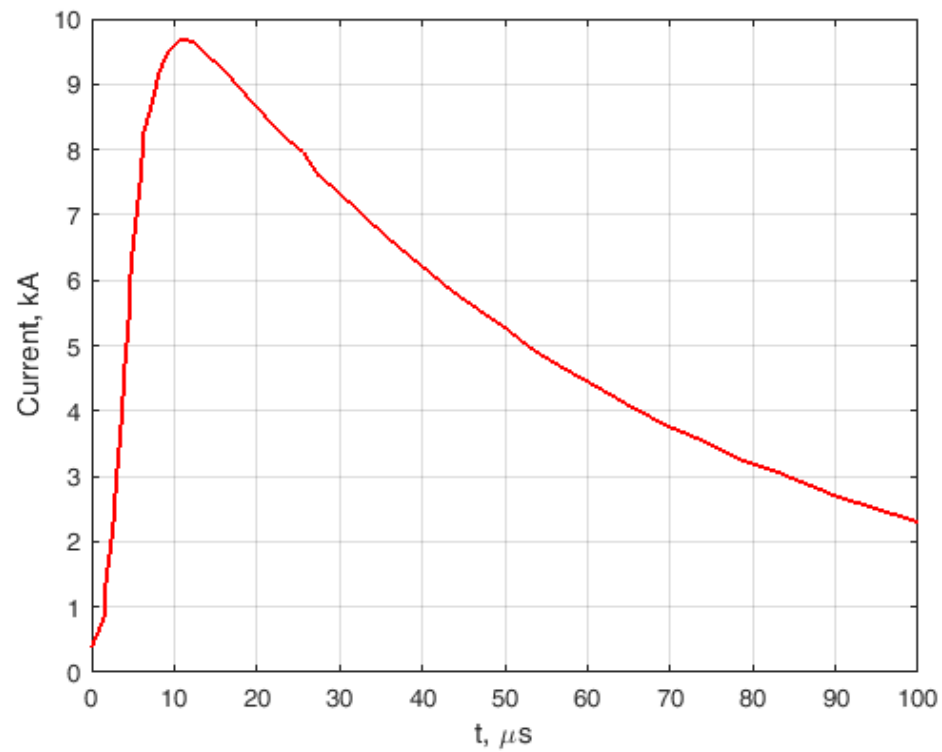

10 kA

SIMULATION RESULTS

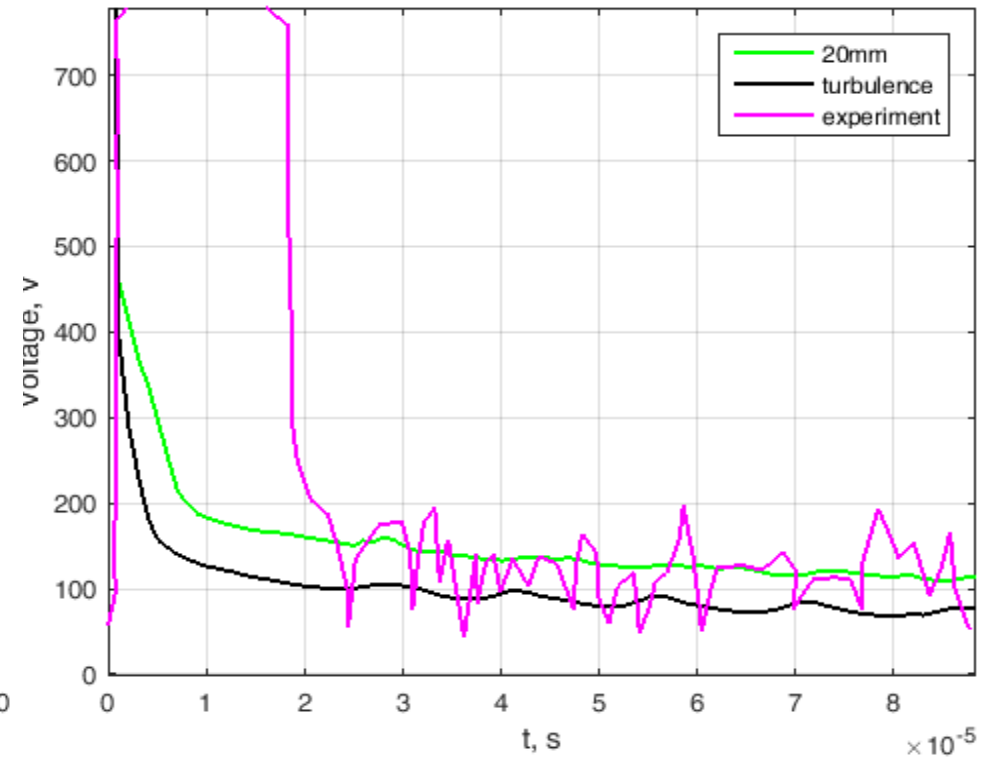
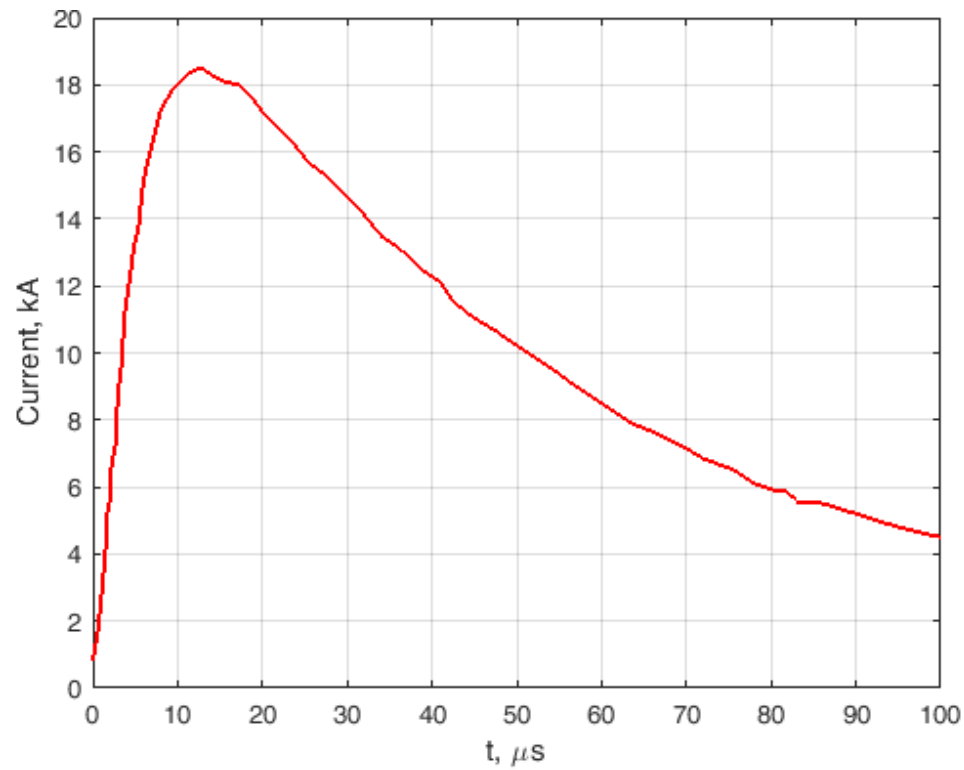

20 kA

SIMULATION RESULTS

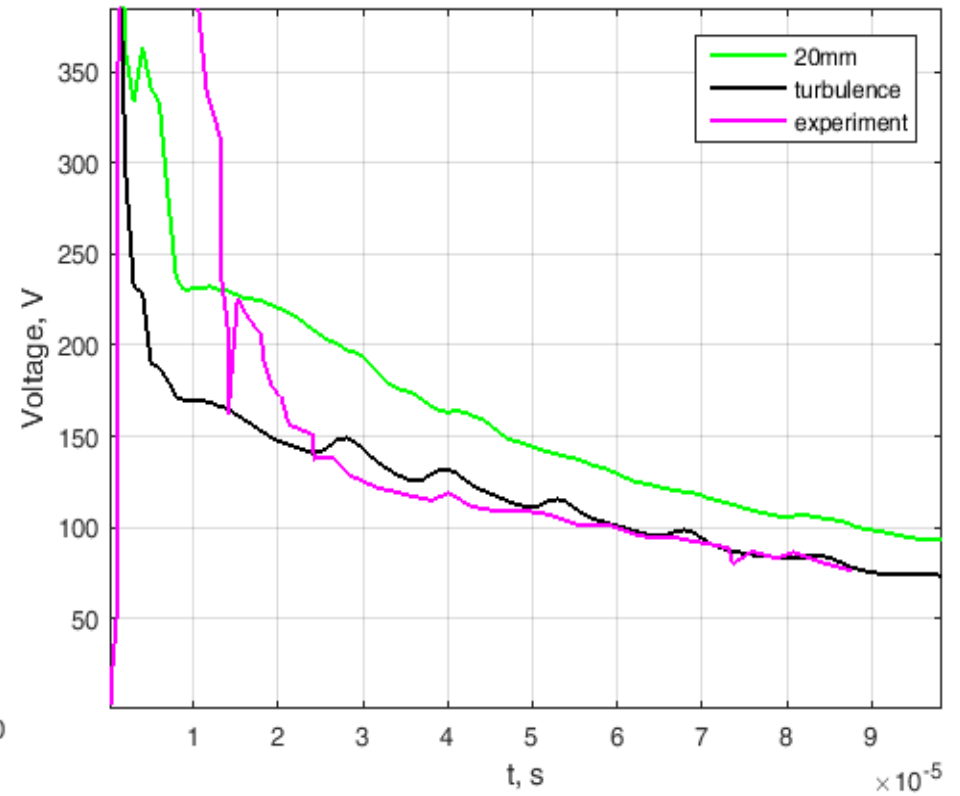
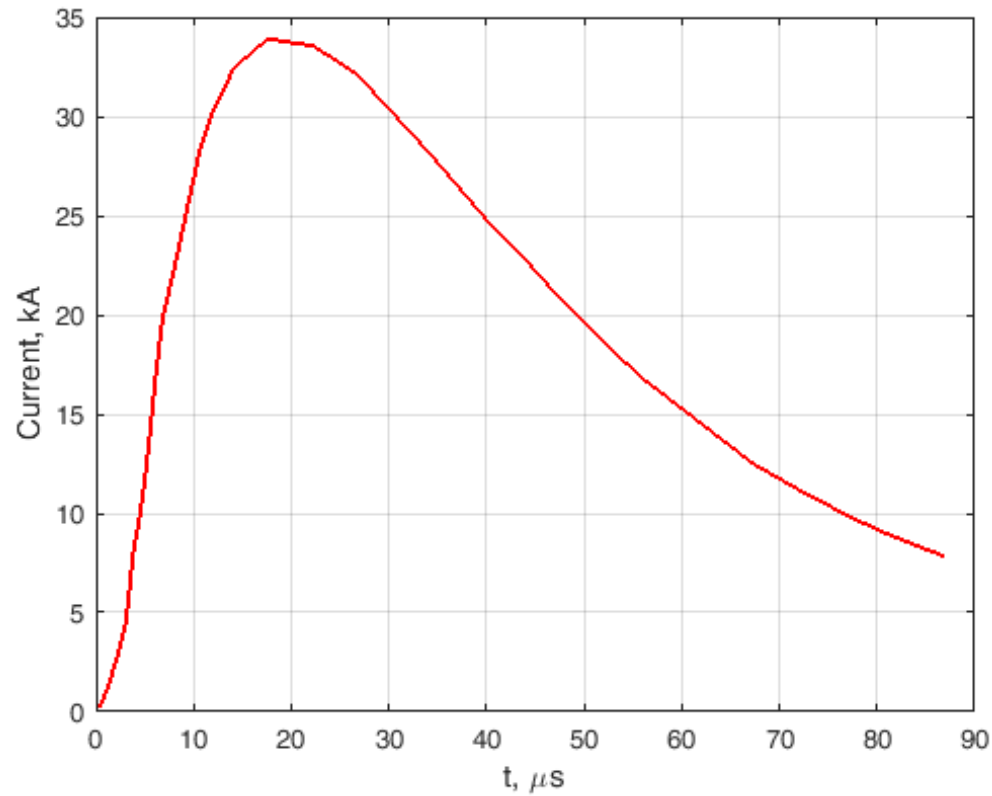

30 kA

SIMULATION RESULTS



Fast-imaging record of plasma jet

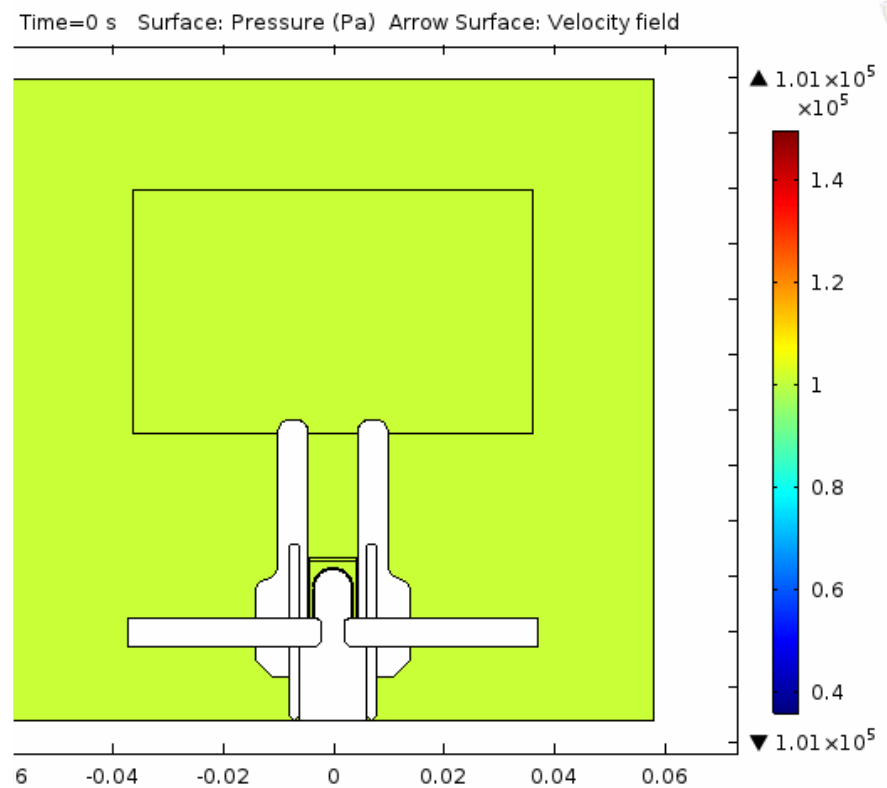
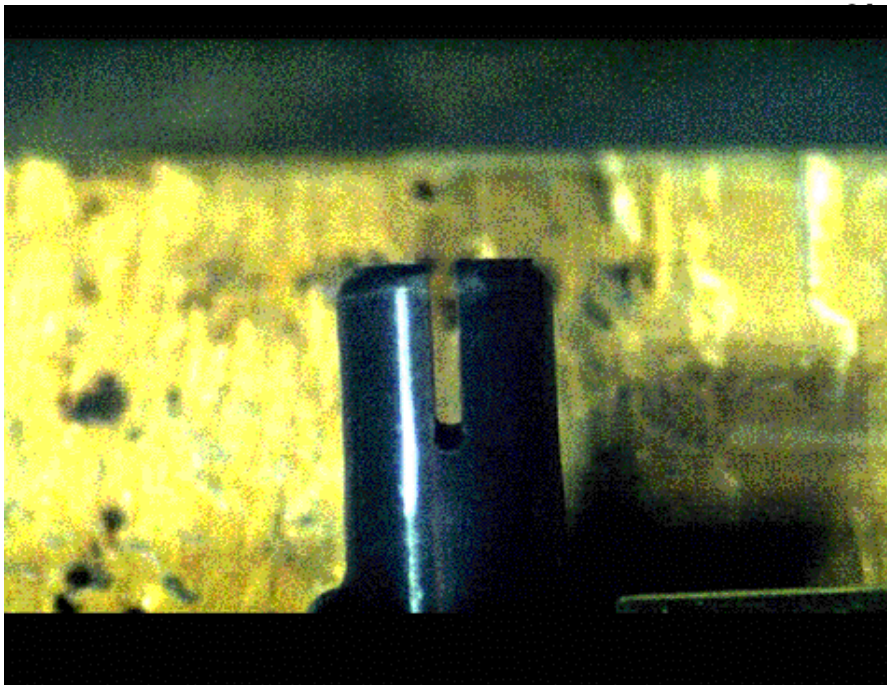

SIMULATION RESULTS

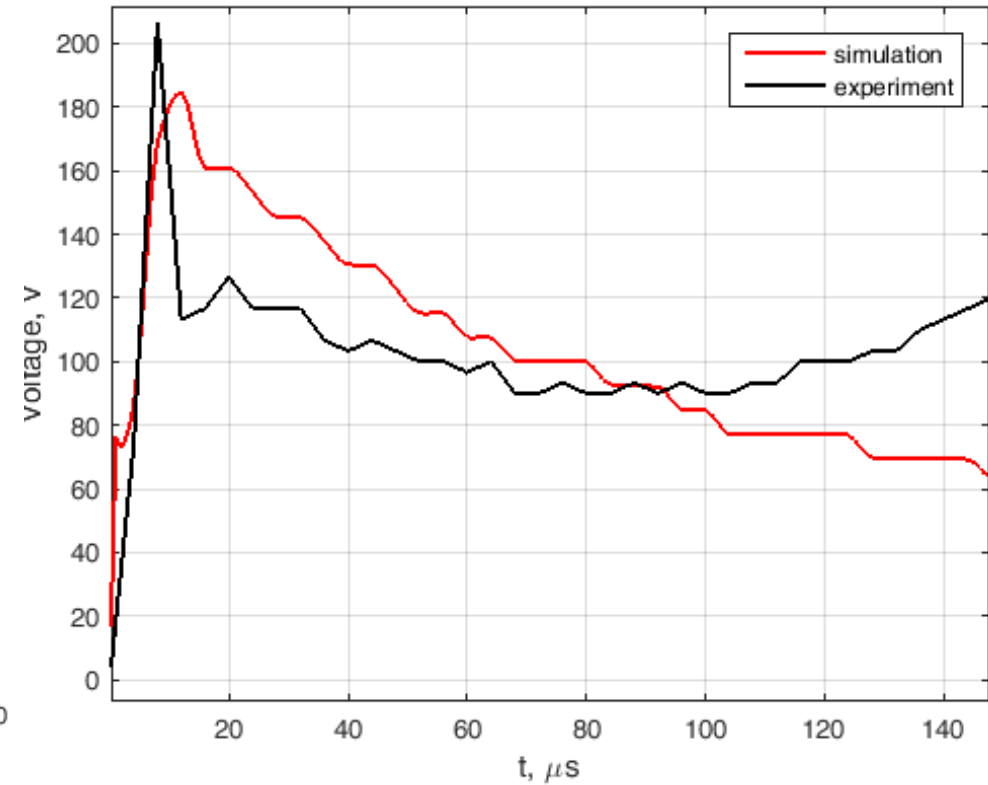
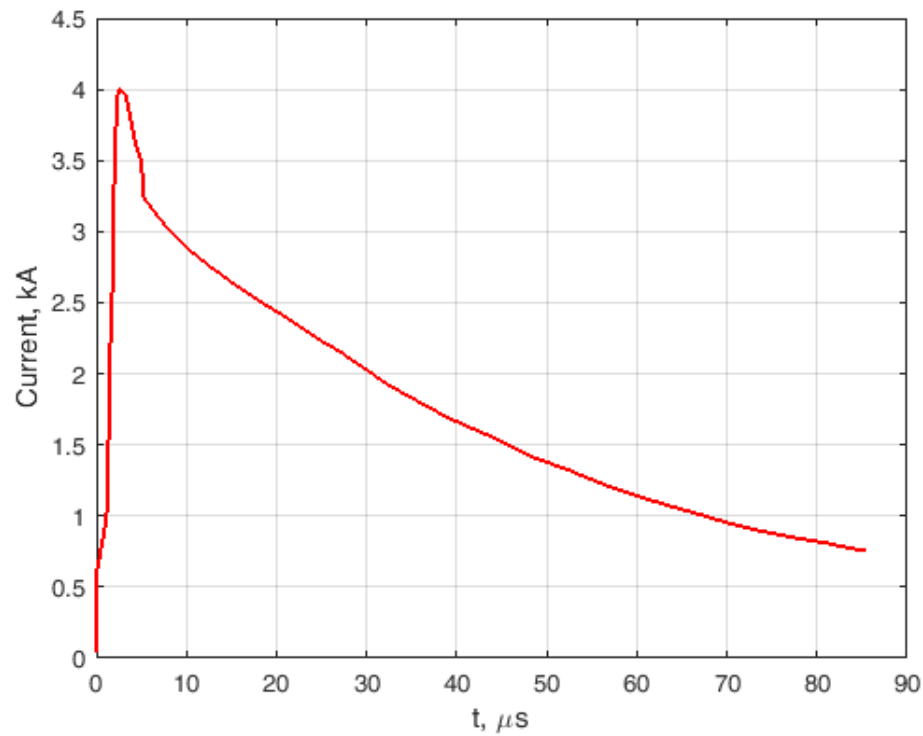

3 kA

SIMULATION RESULTS

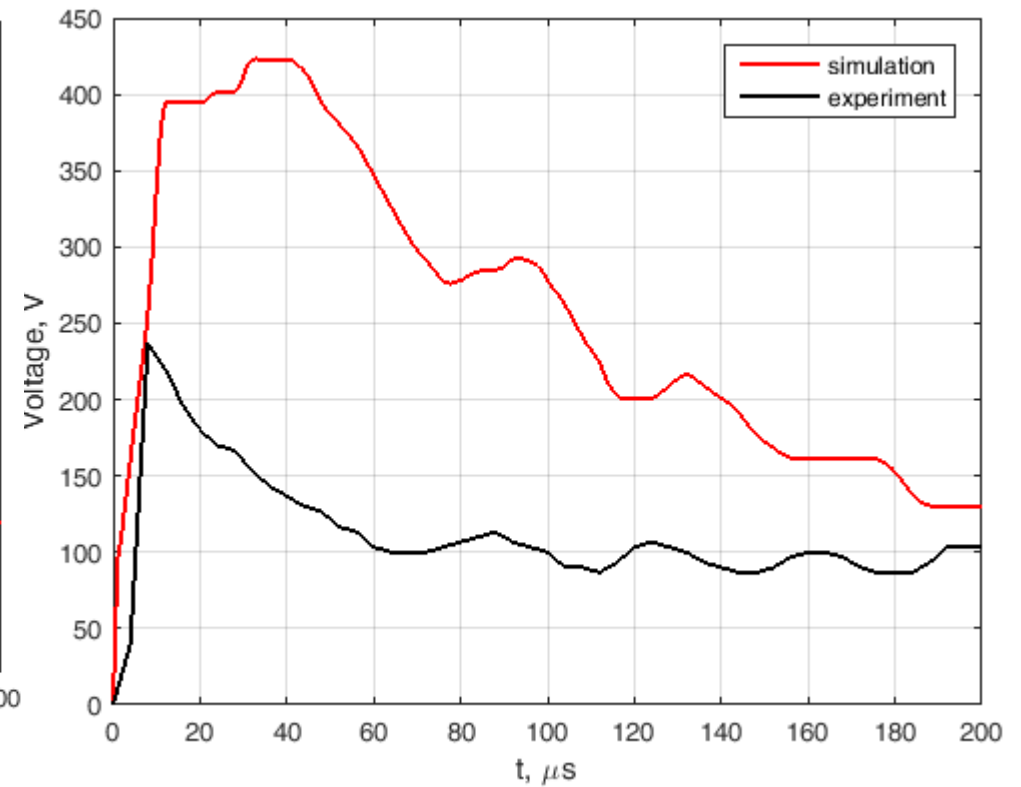
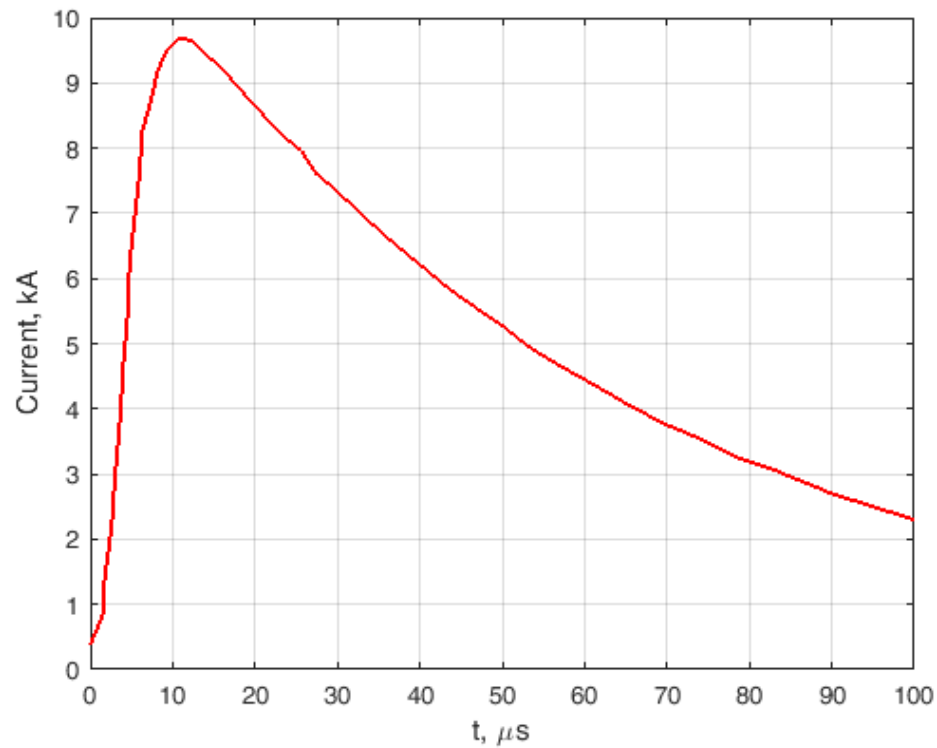

10 kA

SIMULATION RESULTS

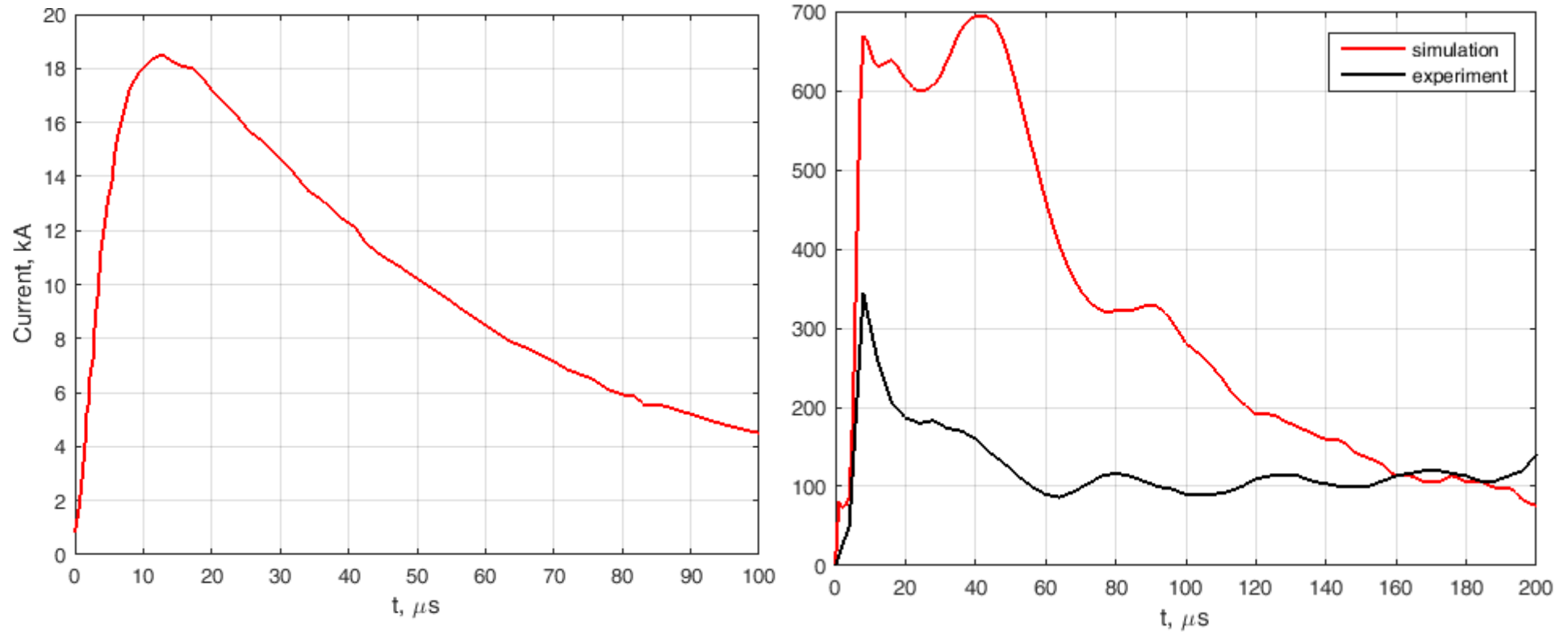

20 kA

SIMULATION RESULTS

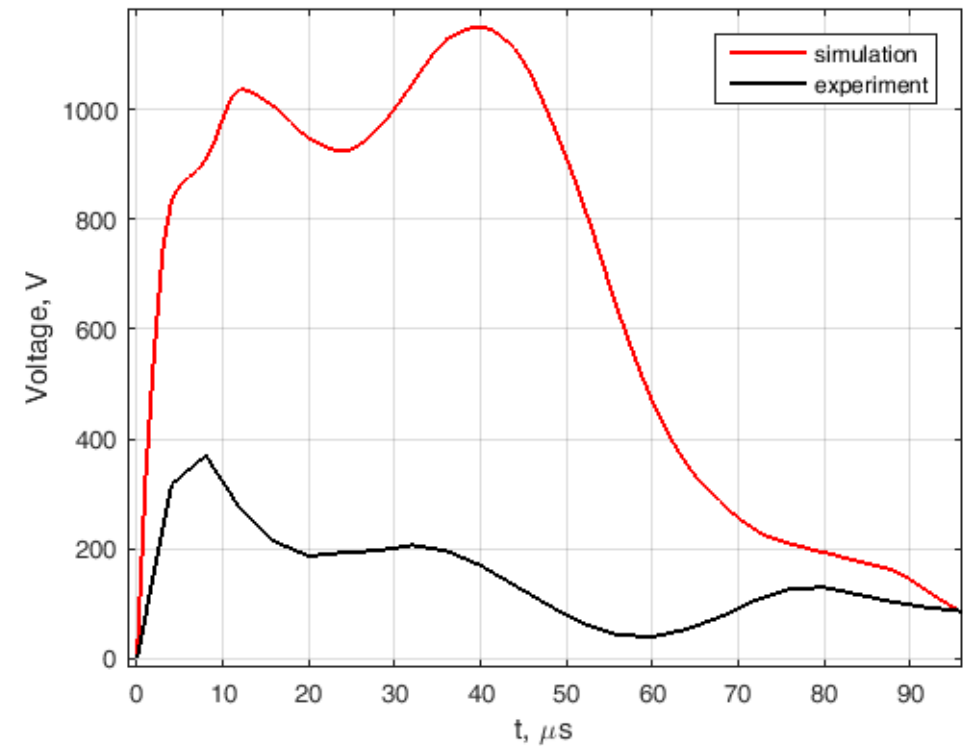
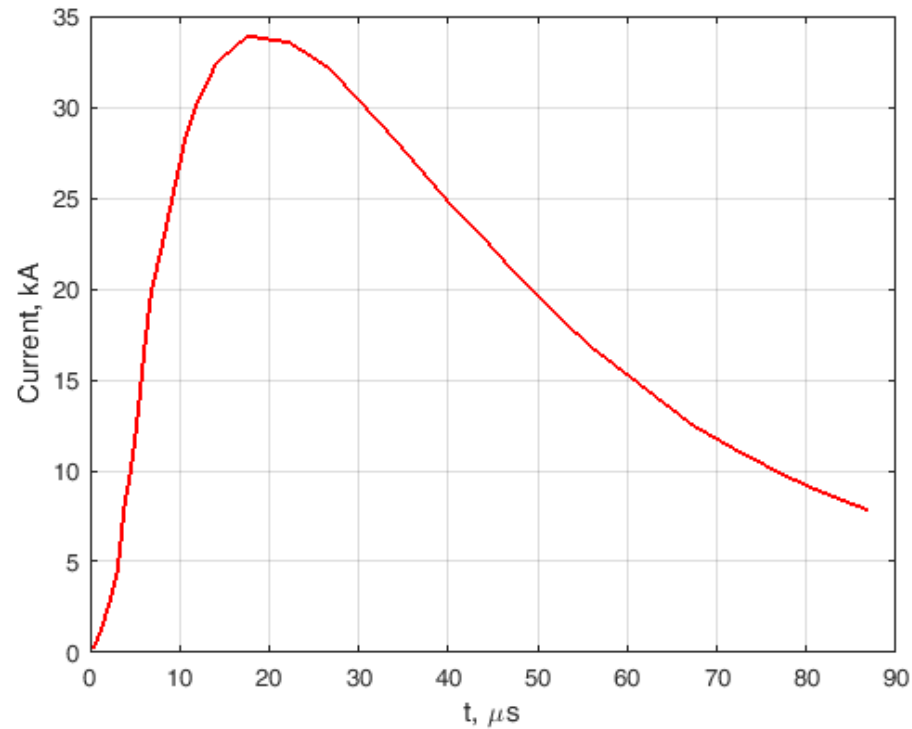

30 kA

SIMULATION RESULTS

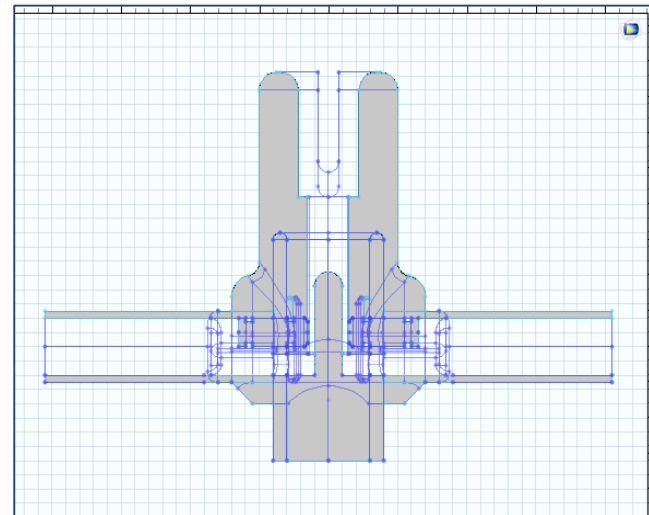
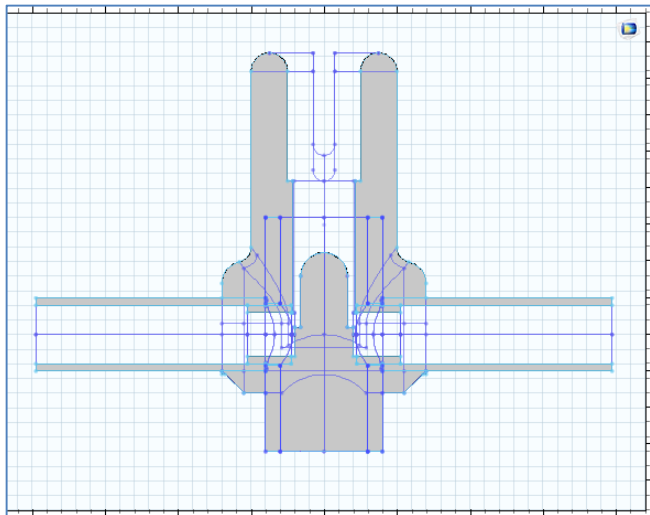
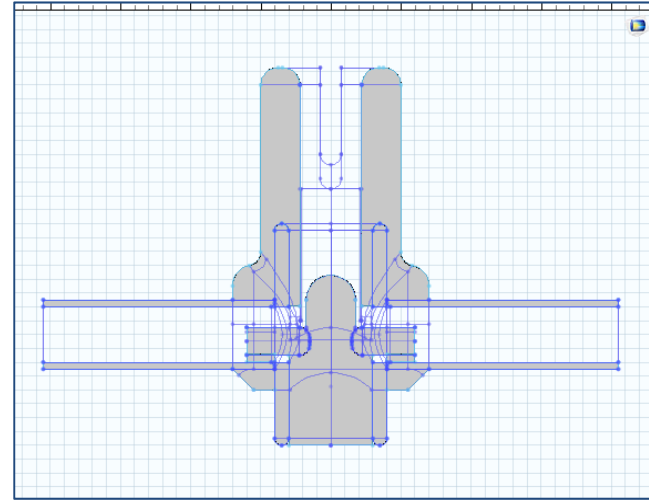
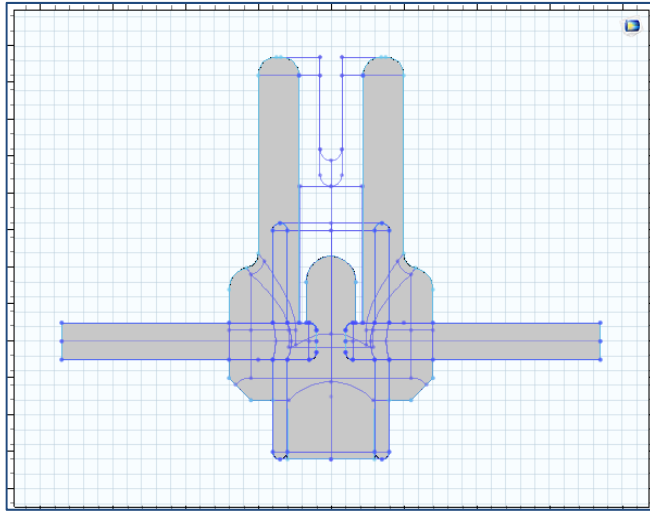

SIMULATION RESULTS:PRESSURE

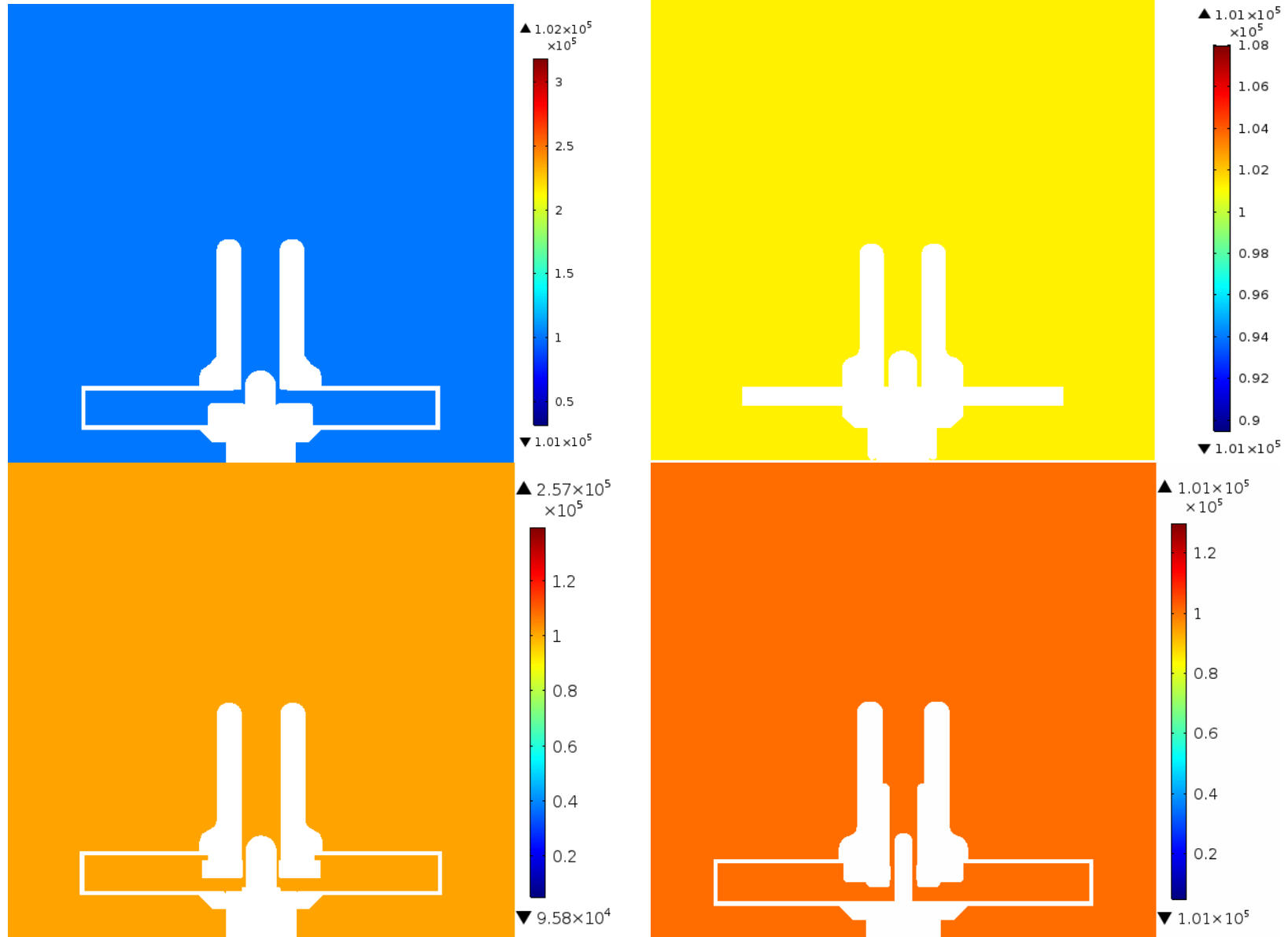

SIMULATION RESULTS:DENSITY

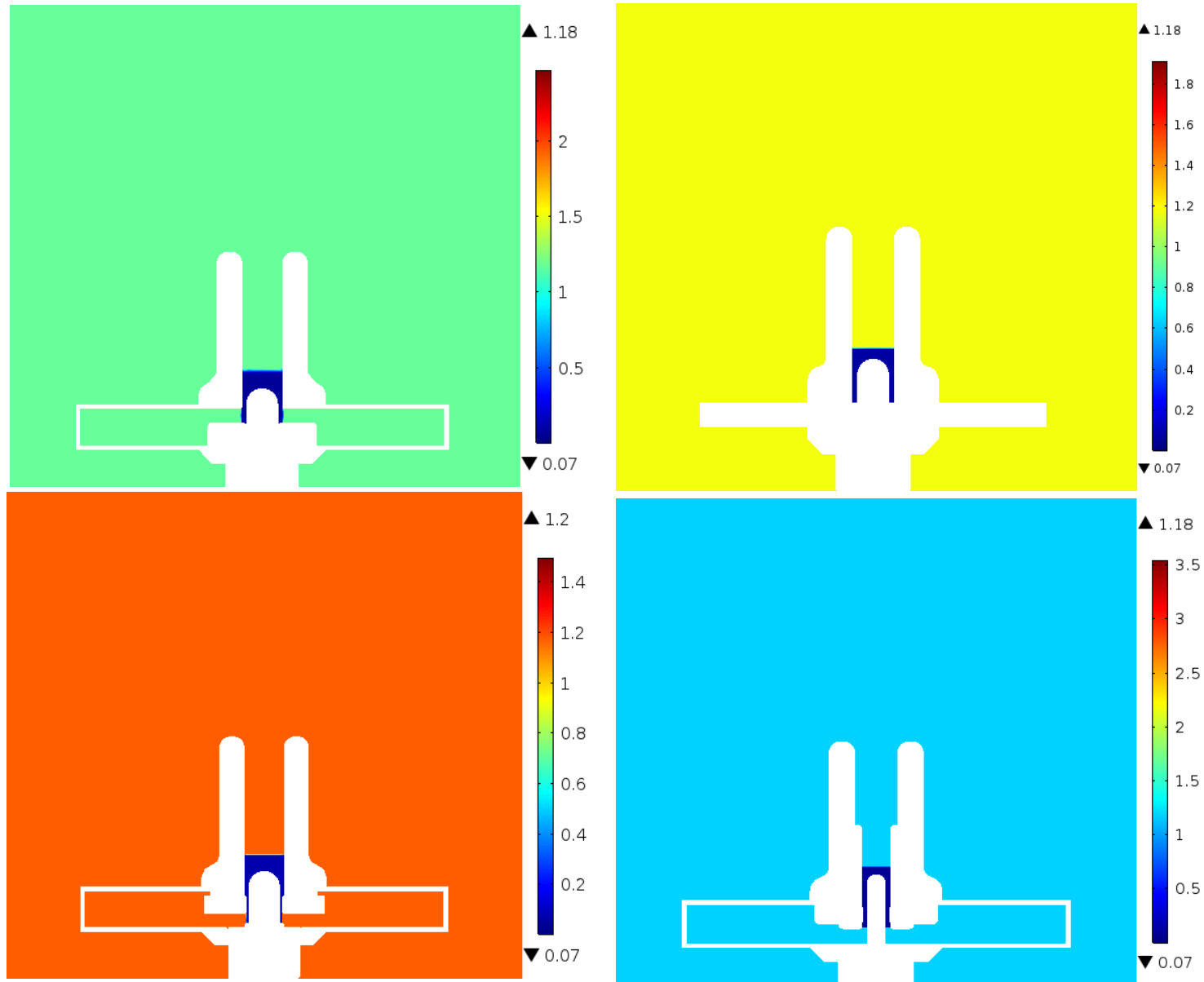

SIMULATION RESULTS: TEMPERATURE

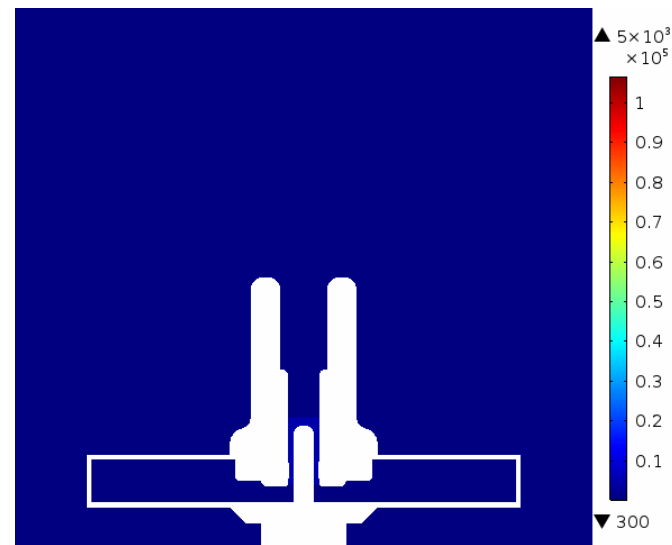
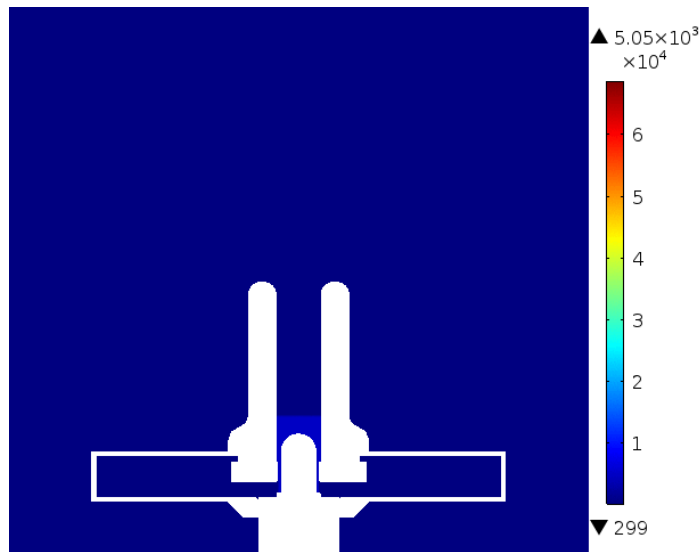
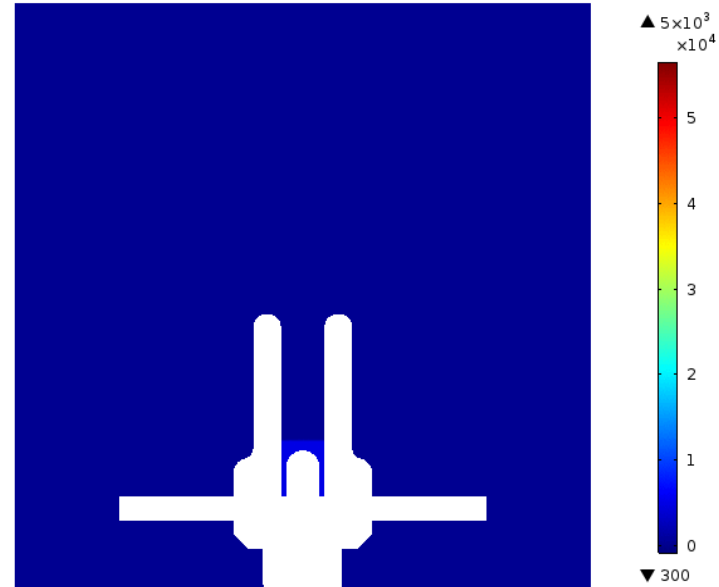
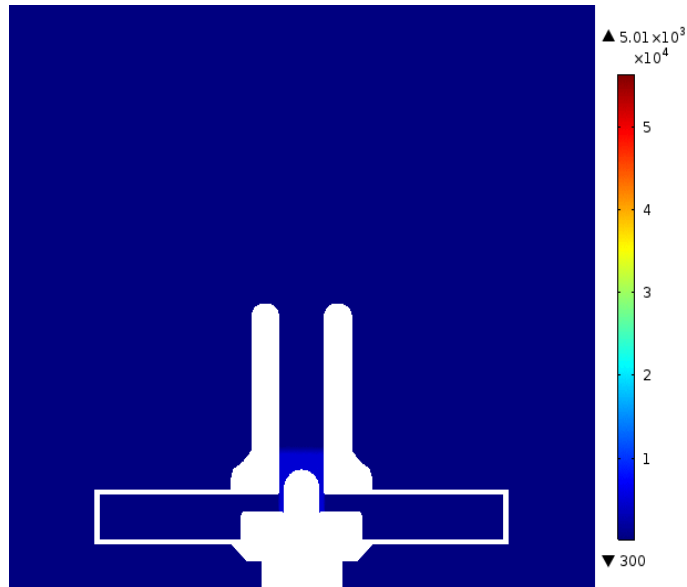

SIMULATION RESULTS: VELOCITY

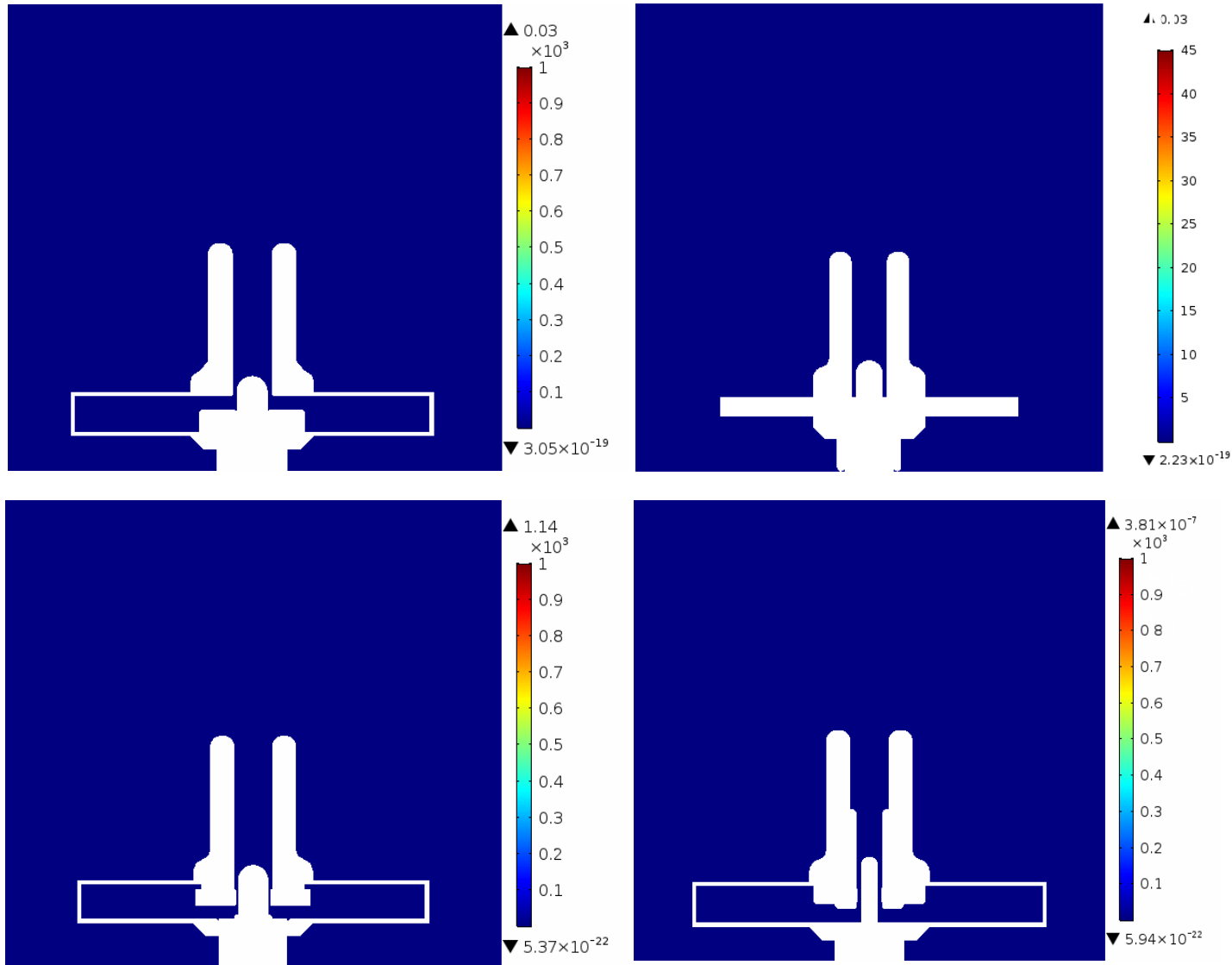

SIMULATION RESULTS



Type #1

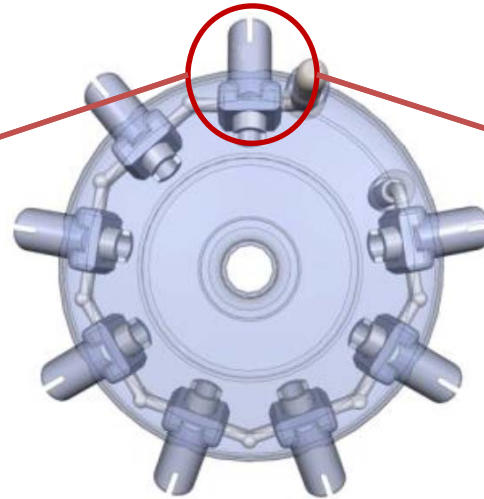

Type #2

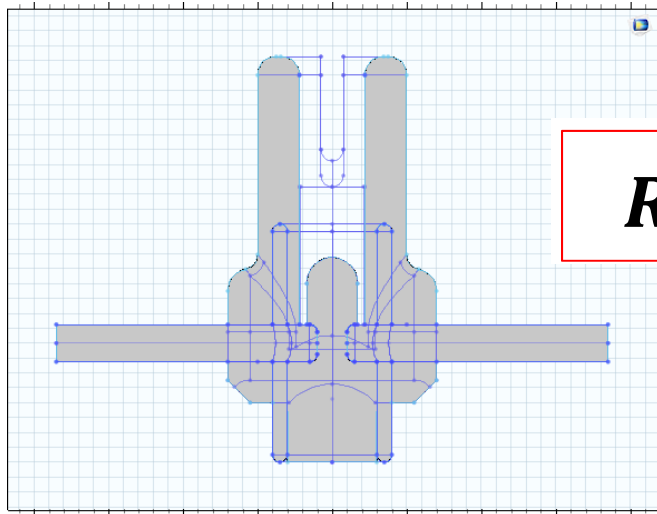

$$R_1^{t=200\mu s} < R_2^{t=200\mu s}$$

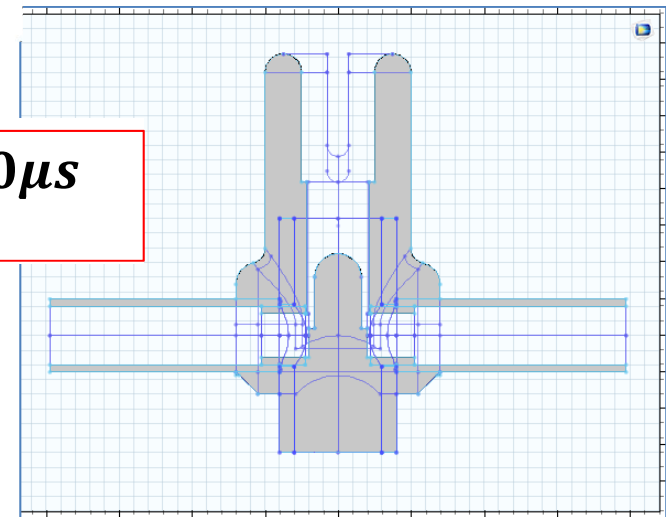

Type #1 is better than Type #2

CONCLUSIONS:

- **Conventional approach to thermal plasma modeling based on MHD is applicable for the case of impulse arcs caused by lightning overvoltage to some certain extent**
- **However current model is lacking some important physics**
- **It could be electrode erosion, chamber geometry deformation, Lorentz force influence, something else**
- **Still numerical simulation is considered as a promising tool for development of future lightning protection devices**



Thank you for your attention!